

# UBC80 Battery Cabinet

## Installation, Operation, & Maintenance Manual

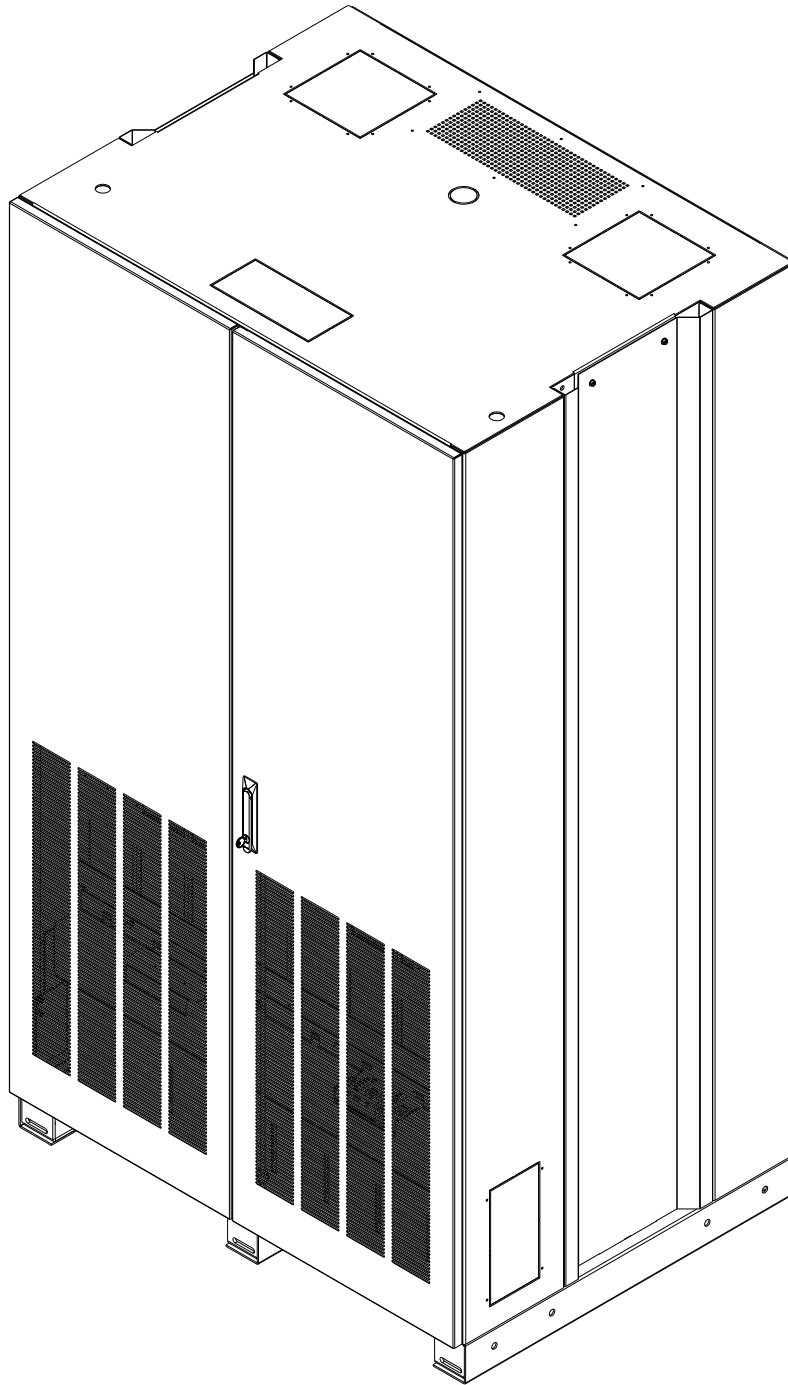



## TABLE OF CONTENTS

1. Important Information About This Manual .....	4
1.1 Manual Symbols .....	4
2. Safety Precautions .....	5
3. Inspection Upon Receipt of Goods.....	7
3.1 General .....	7
3.2 Visible Damage .....	7
3.3 Concealed Damage.....	7
3.4 Return of Damaged Goods .....	7
4. System Overview .....	8
5. System Specifications.....	9
5.1 Batteries.....	9
5.2 System Grounding.....	9
5.3 DC Output .....	9
5.4 General Specifications.....	10
6. Installation .....	11
6.1 Preparation.....	11
6.1.1 Equipment Inspection .....	11
6.1.2 Necessary Equipment and Tools .....	11
6.1.3 Installation Safety Precautions .....	11
6.2 Installation Steps .....	11
6.2.1 Equipment Location .....	11
6.2.2 Equipment Mounting.....	12
6.2.3 Equipment Grounding .....	12
6.2.4 Final Assembly of Battery Cabinet System (If Necessary) .....	13
6.2.5 DC Connections.....	14
6.2.6 System Operation .....	14
7. System Maintenance.....	15
7.1 Battery Replacement .....	15
8. Reference Materials.....	17

## **1. IMPORTANT INFORMATION ABOUT THIS MANUAL**

SAVE THESE INSTRUCTIONS! This manual contains important information that is needed during the installation and maintenance of the system.

### **1.1 MANUAL SYMBOLS**



**Warning / Caution:**

Indicates information provided to protect the user against personal injury, safety hazards, and/or possible equipment damage.



**Important:**

Indicates information provided as an installation or operating instruction or tip as well as general important installation and system information.

## **2. SAFETY PRECAUTIONS**



Before installing or maintaining this system, it is extremely important to read this manual and be sure that all system drawings and schematics are reviewed and clearly understood. If there are any questions concerning this manual or any of the installation or maintenance procedures and/or requirements please contact your system supplier before proceeding.



When installing this power system, follow all applicable federal, state and local regulations as well as industry guidelines to insure proper system installation.



Only qualified electricians or DC power technicians should attempt to install or service this equipment.



System installation and maintenance should always be performed with heavily insulated tools. It is also recommended to wear rubber gloves, boots, and use insulating mats to stand on when working on this equipment.



Always wear eye protection when installing or maintaining batteries and/or power equipment.



Do not attempt to unpack or move the battery cabinet without assistance. Use appropriate handling equipment rated to bear the weight and bulk of the battery cabinet, such as freight elevators, pallet jacks and forklifts. (Fully extend forks under load. Spread forks to maximum possible width under load. Lift cabinet from bottom only. Wear safety shoes.)



Do not smoke or present open flames near any battery system.



For the safety of others, never leave an open cabinet or panel unattended.



To reduce the risk of fire, replace fuses with the same type and rating of fuses supplied with the system.



DC Power and Batteries can be very dangerous and have extremely high short circuit current. Electrical shock, severe burns, fire or death can result from a system short.



To avoid personal injury including electrical shock, severe burns and possible death, all jewelry including bracelets, rings and watches must be removed prior to installing or servicing this system.



Do not open or mutilate batteries. Opened or severely damaged batteries can release toxic electrolyte which is harmful to the skin and eyes.



Never lay loose cables, metal parts or tools on top of batteries.



Under certain conditions, batteries can vent potentially explosive gas (hydrogen). Never enclose batteries or battery cabinets in a sealed room.

### **3. INSPECTION UPON RECEIPT OF GOODS**

#### **3.1 GENERAL**

Special precautions and care have been taken to ensure the system arrives safe and undamaged. However, upon receipt, you should inspect the entire shipment, including the crate and any boxes for evidence of damage that may have occurred during transit.

#### **3.2 VISIBLE DAMAGE**

It is the responsibility of the person receiving the shipment to inventory and fully inspect all materials against the bill of lading or weigh bill IMMEDIATELY while the carrier representative is still present. Insure that all items are accounted for, including number of skids and quantity of boxes. Also note any visible external damage that may have occurred during transit. Make all applicable notations on the delivery receipt before signing and file a damage report with the carrier.

#### **3.3 CONCEALED DAMAGE**

Within 3 to 30 days of receipt (depending on courier), unpack the system and check for any concealed damage. Check the materials received against the detailed packing list to verify the quantity and the condition as complete and satisfactory.

Note any damage to the internal packaging, then request an inspection by the carrier and file a concealed damage claim. If there is a material shortage, contact your system supplier to file a claim.

**Please contact your shipping company for all shipping damage.**

#### **3.4 RETURN OF DAMAGED GOODS**

Should equipment be damaged and require return for repair, a representative will provide instructions along with an RMA number to expedite the return.

**A RMA number must be obtained before returning equipment.**

## **4. SYSTEM OVERVIEW**

During normal operating conditions the UPS or charger supplies power to the load as well as the necessary power required to keep the batteries at the proper float voltage. When AC power fails, the batteries will discharge in order to provide the necessary backup power to the load. It is the responsibility of the customer to make sure the batteries are not discharged below manufactures recommendations. After any battery discharge has occurred, the batteries should be recharged as soon as possible. Batteries will be damaged if not properly recharged right away. See the UPS manual for more information on charging the batteries.

### Optional External Circuit Breaker Access Safety Feature

The option provides functional access to the equipment circuit breaker via a handle located on the exterior of a cabinet door that is physically connected to the circuit breaker in the cabinet's interior.

Putting the circuit breaker in its Closed/On position by using an external handle located on the battery cabinet door accomplishes the following;

1. Connects the battery cabinet to the UPS
2. Automatically locks the battery cabinet door to prevent access to the cabinet interior during its operation as a power backup to the UPS.

Putting the circuit breaker in its open/off position by using an external handle located on the battery cabinet door accomplishes the following;

1. Isolates the battery cabinet from the UPS
2. Divides the 480VDC battery string into two (2) battery strings of 240VDC each.
3. Unlocks the battery cabinet doors to allow access to the cabinet interior for component maintenance or battery replacement purposes.

The division of the 480VDC battery string into two (2) 240VDC battery strings reduces the battery cabinet's latent electrical shock intensity. This allows a minimization of the required high voltage protective gear needed to be worn by maintenance personnel when servicing the battery cabinet.



**5. SYSTEM SPECIFICATIONS**

**5.1 BATTERIES**

Please refer to system drawings for model specific information.

**Type:** Valve Regulated Lead Acid (VRLA), sealed, non-spillable

**Voltage:** 12 VDC Nominal

 Only cabinets with **Flame Retardant Batteries** are suitable for computer room use.

**5.2 SYSTEM GROUNDING**

 All system ground wires should be derived from the main building ground source.

**Cabinet Safety Ground:** Each cabinet is supplied with a mechanical ground lug that accepts bare wire from #14 AWG to 1/0 AWG cable.

**Torque:** 55 lb-in

**Wire Size and Type:** Ground wire should be sized per NEC and/or all applicable national and local codes.

Minimum Size Conductor for Grounding the Battery Cabinet		
Battery Cabinet Breaker or Fuse Size	Copper Wire Size	Aluminum Wire Size
Up to 200 Amps	6 AWG	4 AWG
201-300 Amps	4AWG	2 AWG
301-400 Amps	3AWG	1 AWG
401-500 Amps	2 AWG	1/0 AWG
501-600 Amps	1AWG	N/A

**5.3 DC OUTPUT**

Please refer to system drawings for model specific information.

**Voltage:** 12-480 VDC Nominal

**Circuit Breaker:** UL Listed 600 VDC rated. See system drawings for details.

**Fuse Type:**

A50P (for 384VDC Nominal bus or less)

A70P (for 480VDC Nominal bus or less)

HSJ

**Wire Size and Type:** Per 75°C rating; size per NEC Table 310.16 and/or all applicable national and local codes.

 Wire should be sized for a maximum voltage drop of 0.5 volt.

#### **5.4 GENERAL SPECIFICATIONS**

**Cabinet Size:** 46.5"W x 35.5"D x 84"H

**Empty Cabinet Weight (approximately):** 1000 lbs.

**Operating Temperature:** See battery specifications for optimal operating temperatures.

**Ventilation:** Through ventilation openings on the front, rear, and top of the cabinet. Clearance around the equipment should be as suggested by NEC and/or all applicable national and local codes. A minimum rear clearance of 2 inches is recommended for optimal cooling of the equipment.



Under certain conditions, batteries can vent potentially explosive gas (hydrogen). Never enclose batteries or battery cabinets in a sealed room.



Batteries should be stored according to the battery manufacturers. Exceeding the recommended ambient storage temperature or duration may cause damage to the batteries.

## **6. INSTALLATION**

### **6.1 PREPARATION**

#### **6.1.1 EQUIPMENT INSPECTION**

Remove the equipment from the packaging material and inspect for any shipping damage that may have been overlooked upon receipt of goods. Verify that the system includes all necessary hardware for installation.

#### **6.1.2 NECESSARY EQUIPMENT AND TOOLS**

- Heavily insulated assortment of hand tools
- Digital voltmeter

#### **6.1.3 INSTALLATION SAFETY PRECAUTIONS**



Before proceeding with system installation, be sure to review and understand all of the SAFETY PRECAUTIONS in this manual!



#### **DC VOLTAGE WARNING!**

**Hazardous DC voltages are present in the system. This hazard will always be present in a battery system including when it is offline. Accidental short circuit of the positive and negative terminal will cause tremendous currents to flow resulting in electrical shock, severe burns, fire and possible death! Use extreme caution when installing and maintaining the system!**

### **6.2 INSTALLATION STEPS**



Before installing or maintaining this system, it is extremely important to read this manual and be sure that all system drawings and schematics are reviewed and clearly understood. If there are any questions concerning this manual or any of the installation or maintenance procedures and/or requirements please contact your system supplier before proceeding.

#### **6.2.1 EQUIPMENT LOCATION**

Prior to installation, verify floor loading requirements and all applicable codes pertaining to the related equipment. Environmental conditions should also be reviewed. Battery systems require an area with proper ventilation and cooling. Optimal ambient temperatures specified by the battery manufacturer are recommended for optimum battery life and performance. A minimum rear clearance of 2 inches is recommended for optimal cooling of the equipment. Clearance around the equipment should be as suggested by NEC and/or all applicable national and local codes.



Under certain conditions, batteries can vent potentially explosive gas (hydrogen). Never enclose batteries or battery cabinets in a sealed room.

**6.2.2 EQUIPMENT MOUNTING**

 Do not attempt to unpack or move the battery cabinet without assistance. Use appropriate handling equipment rated to bear the weight and bulk of the battery cabinet, such as freight elevators, pallet jacks and forklifts. (Fully extend forks under load. Spread forks to maximum possible width under load. Lift cabinet from bottom only. Wear safety shoes.)

1. The battery cabinet is equipped with pallet jack and/or forklift access openings in the front and rear of the cabinet. Move the equipment into the desired location and set into place.
2. On the floor in the desired location, mark the location of the 6 mounting holes found at the bottom of the 3 cabinet legs. Each leg has 2-3 mounting holes available. Only 2 of the 3 available holes per leg (1 front and 1 rear) should be used to mount the equipment.
3. Move the cabinet out of the way and drill holes for the mounting hardware that will be used.
4. Move the cabinet back into place, align the holes, and tighten the hardware.
5. If required, there are holes inside the cabinet that allow access to the rear mounting bolts.

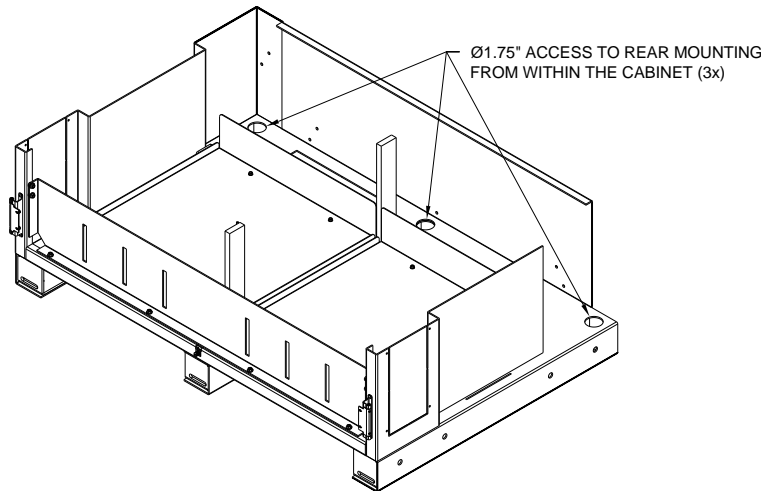

When mounting the UBC80 using the optional mounting brackets, please refer to the installation summary located in Section 8 of this manual.

**6.2.3 EQUIPMENT GROUNDING**

 All system ground wires should be derived from the main building ground source.

 For multi cabinet systems, each cabinet needs to have a designated cabinet ground wire derived from the main building ground source.

Terminate a cabinet ground wire from the main building ground source to the supplied #14-1/0 AWG mechanical lug located on the breaker pan. See section 5.2 for sizing recommendations. Wire should be sized per NEC and/or all applicable national and local codes.

NOTE! If the Battery Cabinet System is fully assembled, proceed to Section 6.2.5. If not, go to Section 6.2.4.

#### **6.2.4 FINAL ASSEMBLY OF BATTERY CABINET SYSTEM (IF NECESSARY)**

Depending on a Battery Cabinets' size, normally based on the number of lead-acid type batteries required to meet the electrical specifications of the battery system, weight considerations (e.g. freight elevator and lift truck maximum capacity loads) may preclude shipping the system fully assembled; that is with the batteries installed and all electrical connections complete in the cabinet prior to delivery. A large system can be shipped with none or some of its required number of batteries installed and it will be dependent on the customer to arrange for installation and wiring of the system upon arrival at its premises. The following instructions are recommended for final assembly of the battery system:

1. Whether the Battery Cabinet is empty or partially assembled, it should be located, mounted and *properly grounded prior to final assembly as instructed in this manual in sections 6.2.1, 6.2.2 and 6.2.3 respectively.*
2. Review the battery system schematic that is located attached to the inside of a cabinet door to determine the number of batteries that need to be installed in the cabinet, the position of these batteries on the shelves, the battery terminal interconnections required to form the battery string, and the cabling of the battery string to the output circuit breaker.
3. Identify and count the cables to be used for the battery string connection to the circuit breaker and the flexible bus bars used for battery terminal interconnections. Assure that the parts count meet the assembly requirements.

**For safety reasons, the following installation sequence must be followed without deviation:**

4. Install all the batteries required by the system and secure all battery hold-downs, if any are required by the Battery Cabinet Model being assembled. **Safety Note! Batteries are very heavy!** Use appropriate lifting equipment to raise the batteries to the proper height to insert (slide) them in to the channeled slots on the battery cabinet shelves.

Note! In the following Installation Instruction, torque all cable and bus bar connections to battery terminals. Proper torque values are noted on the system drawing (that has the system schematic) and also this value can be found on most battery cases.

5. Install the main POS and NEG cables from the output circuit breaker to the correct battery posts on the designated battery units shown in the provided battery system schematic.
6. Install all inter-shelf jumper cables: These provide connection between designated batteries located on adjacent shelves. Refer to the provided battery system schematic.
7. Using the battery system schematic as reference, install the supplied flexible bus bars interconnecting adjacent batteries on a shelf; but leave the bus bar connection between the two batteries in the middle of the shelf un-installed at this time. Repeat this procedure for each battery shelf.
8. On a selected shelf, place a Voltmeter between the two battery terminals where a bus bar was not installed in Step 7. The Voltmeter **must** read zero volts. If true, install the missing bus bar between the two middle batteries on this tier. If the voltage read is not zero, STOP THE INSTALLATION.....there is a short-circuit fault somewhere in the battery system. This fault must be cleared before proceeding. Repeat this procedure for all the battery shelves.

9. Check the voltage at the Output Circuit Breaker to insure it meets system specifications.
10. If the battery system includes a battery monitoring option, the battery monitoring components should be attached and wired into the circuit at this time. The battery monitor system will have separate installation instructions.
11. Install the Polycarbonate Retainer and Raceway on each cabinet battery shelf. Dress the inter-shelf battery terminal connection cables into these raceways to contain these cables.
12. Proceed to Item #4 in Section 6.2.5 of this manual.

### **6.2.5 DC CONNECTIONS**



Review the attached system drawings and schematics for model specific information on DC output connections.



Wire should be sized for a maximum voltage drop of 0.5 volt.



Battery cabinets that are not supplied with an incorporated DC output disconnect device must have an appropriate disconnect device provided external to the cabinet.



Verify that the output breaker is in the off/open position before making any DC connections to additional cabinets or to the UPS. Also verify that the UPS charger is not running.

1. Open the front doors on the cabinet and check for any noticeable problems or damage that may have occurred during shipment.
2. Review the attached system schematic located inside the cabinet doors to find the location of the jumper that has been left off in the middle of the battery string for added safety during installation and shipping. This jumper will be installed later.
3. Check and re-torque all internal battery connections, as shipping may have caused these connections to come loose. Proper torque values are noted on the system drawing and can also be found on most battery cases.
4. Connect main cables from the UPS or charger source to the battery cabinet output. The battery cabinet output connection point will vary depending on the cabinet configuration. The main output connection point may be directly to the circuit breaker, to the fuse block, or to a terminal block or bus bars. Review the supplied cabinet drawing for information on the battery cabinet output. All cables should be sized per Sections 5.2 and 5.3 of this document. Refer to the UPS or charger manual for wiring external batteries. Note: Make sure charging source is disconnected before making these connections.
5. Connect the jumper that was left off during shipment and install as shown on the system schematic. Torque connections properly.

### **6.2.6 SYSTEM OPERATION**

Please refer to the UPS system manual for system start up and operation information.

## **7. SYSTEM MAINTENANCE**



Before proceeding with system maintenance, be sure to review and understand all of the SAFETY PRECAUTIONS in this manual!



Verify that the output breaker is in the off/open position before servicing the system.

### **7.1 BATTERY REPLACEMENT**



When batteries are replaced they must be properly installed paying special attention to terminal polarity orientation! If wired incorrectly it will cause a short in the system and can result in electrical shock, severe burns, fire and possible death! Be sure to review the system schematics before terminating any battery cables.



Caution: Risk of explosion if batteries are replaced by an incorrect type.



Do not dispose of batteries in a fire. The batteries may explode. Contact your local hazardous waste or recycling center for battery disposal requirements.

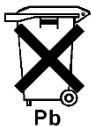

Do not discard batteries in the trash. This product contains sealed lead acid batteries. Contact your local hazardous waste or recycling center for battery disposal requirements.

1. Prepare the new battery for installation. Verify that the battery is the same type and amp-hour rating as the batteries that are in the system.
2. Using a digital voltmeter, measure the battery voltage to verify that it is 12.4 VDC or above.
3. Use a brass wire brush or abrasive pad to polish the battery terminals.
4. Apply no-ox type terminal grease to the battery terminals to avoid corrosion.
5. Disconnect the UPS from the battery string by turning off/opening the circuit breaker in the battery cabinet.
6. Remove the center jumper on the battery string to reduce the voltage. If replacing all batteries, continue reducing the voltage by removing the inter-shelf jumpers.
7. Disconnect the cables from the battery to be replaced.
8. Remove the bad battery. Depending on battery location, it may be necessary to remove additional batteries to safely gain access to the bad battery.
9. Put the new battery into place. Make sure new battery is installed properly regarding polarity orientation. Use the supplied wiring drawing found inside the battery cabinet door to verify the cabinet wiring.
10. Reconnect the cables to battery and make sure the connections are properly torqued.
11. Reconnect any removed string jumpers and make sure the connections are properly torqued.

12. Check the battery string voltage at input side of the circuit breaker.
13. Reconnect the UPS to the battery string by turning on/closing the circuit breaker in the battery cabinet.



**8. REFERENCE MATERIALS**

OPTIONAL SEISMIC MOUNTING BRACKETS-1

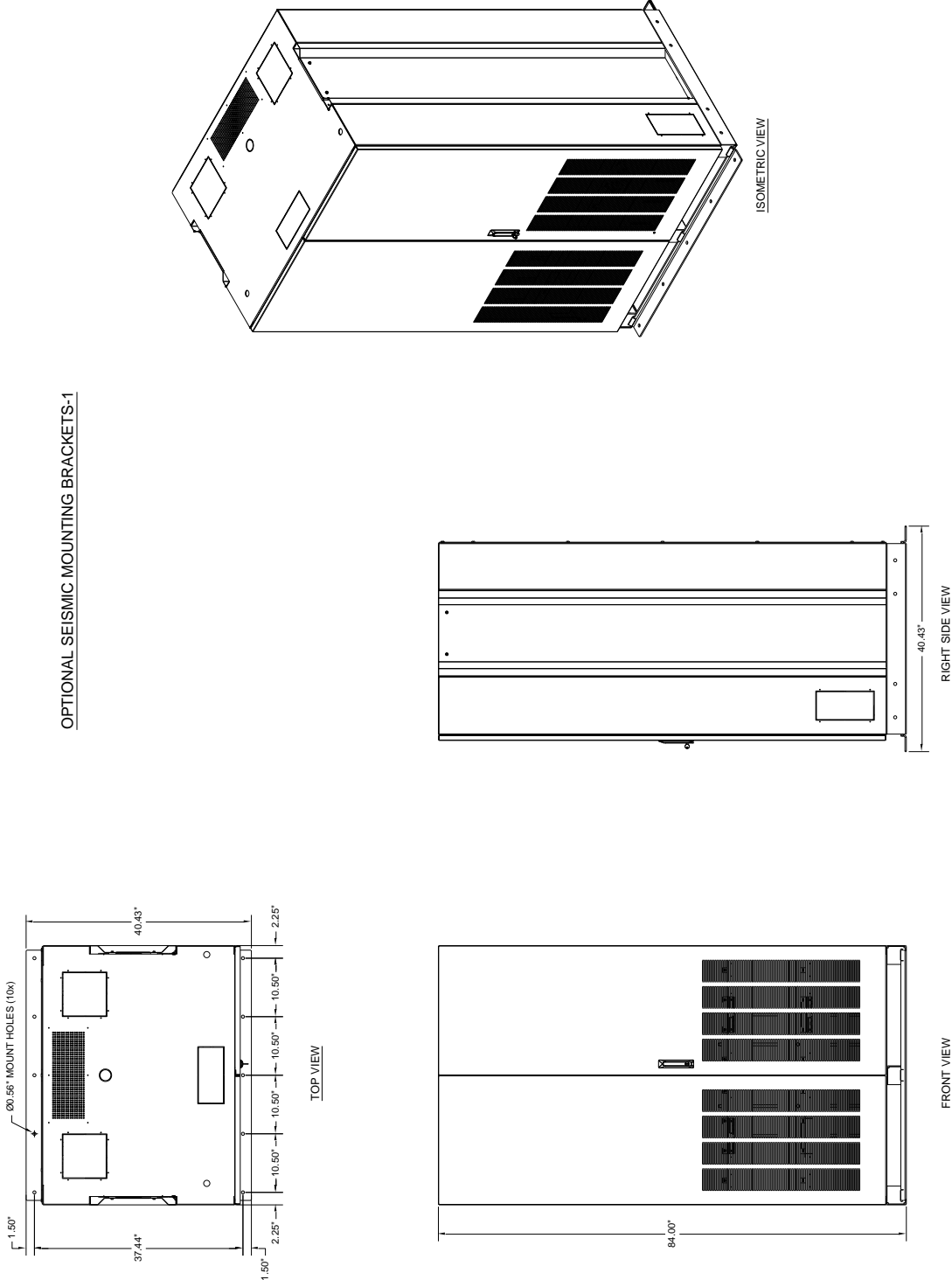

OPTIONAL SEISMIC MOUNTING BRACKETS-2

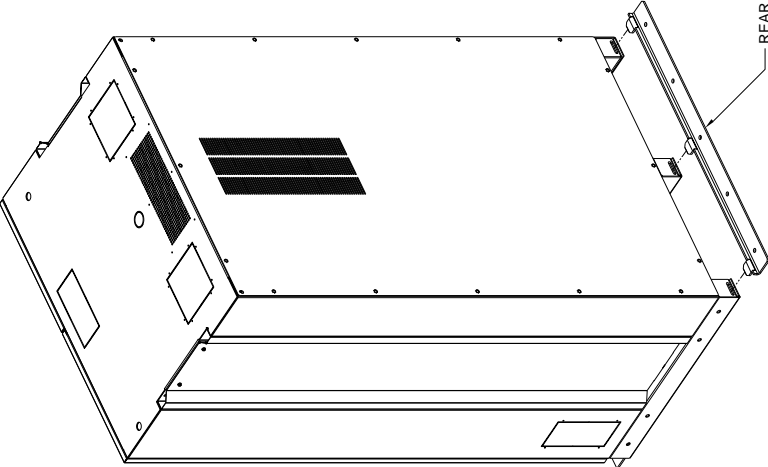

REAR ISOMETRIC VIEW

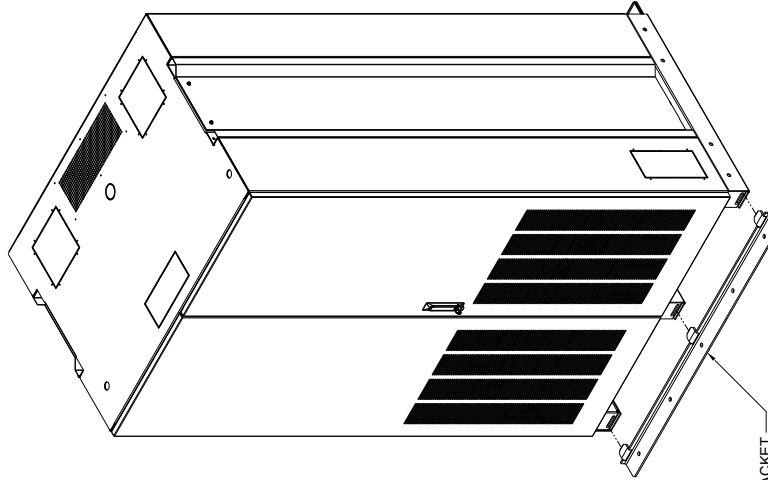

FRONT ISOMETRIC VIEW

- OPTIONAL MOUNTING BRACKET INSTALLATION SUMMARY:
1. SECURE THE REAR MOUNTING BRACKET TO FLOOR. REFERENCE THE IBC/CBC ANCHORAGE DRAWING FOR MOUNTING DETAILS.
  2. MOVE THE BATTERY RACK INTO PLACE BY ALIGNING THE REAR MOUNTING BRACKET TABS WITH THE CUTOUTS IN THE BATTERY RACK LEGS. MOVE THE BATTERY RACK INTO PLACE ENSURING THAT THE TABS FROM THE REAR MOUNTING BRACKET ARE FULLY INSERTED INTO THE CUTOUTS.
  3. FIT THE FRONT MOUNTING BRACKET INTO PLACE BY ALIGNING THE TABS WITH THE CUTOUTS IN THE FRONT LEGS OF THE BATTERY RACK. MOVE THE FRONT MOUNTING BRACKET INTO PLACE ENSURING THAT THE TABS ARE FULLY INSERTED INTO THE BATTERY RACK CUTOUTS.
  4. SECURE THE FRONT MOUNTING BRACKET TO THE FLOOR. REFERENCE THE IBC/CBC ANCHORAGE DRAWING FOR MOUNTING DETAILS.

INTER-SHELF HARDWARE STACKING DETAIL

