

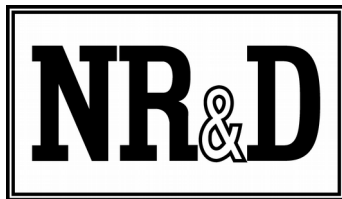
# MUCM Modbus/Mitsubishi UPS

## Installation and Programming Manual

---

This manual describes the MUCM application for interfacing a Mitsubishi UPS to a Modbus serial network.

Effective: March 16, 2015



Niobrara Research & Development Corporation  
P.O. Box 3418 Joplin, MO 64803 USA

Telephone: (800) 235-6723 or (417) 624-8918  
Facsimile: (417) 624-8920  
<http://www.niobrara.com>

---

All trademarks and registered trademarks are the property of their respective owners.  
Subject to change without notice.

© Niobrara Research & Development Corporation 2015. All Rights Reserved.

---

## Contents

1	Introduction.....	7
2	Installation.....	9
	Module Installation.....	9
	Serial Connections to the MUCM.....	10
	Port 1 to 9-pin UPS.....	10
	Port 1 to 25-pin UPS.....	11
	Port 2 to Modbus Network.....	11
	MUCM Application Configuration.....	12
3	Modbus Operation.....	17
	UPS Device Types.....	18
	2033C Register List.....	18
	1100, 2033D, 7011A, 9800AD, 9800AE, 9900A, and 9900B Register List.....	22
	2033A and 9700 Register List.....	26
	"Old" 2033A Register List.....	32
4	LonWorks.....	35
	2033C Neuron Program.....	43
	2033D Neuron Program.....	45
5	Examples.....	49
6	Testing and Troubleshooting.....	53
	MUCM Lights.....	53
	Testing the UPS Connection.....	53
	Testing the Modbus Connection.....	54
7	Front Panel Operation.....	59
	Keypad Buttons.....	59
	LCD Screen.....	59
	Backlight.....	59
	Splash Screen.....	59
	Main Menu Screen.....	60
	UPS Data.....	61
	Config Menu.....	63
	UPS Type.....	63
	Port 2 Menu.....	64
	Mode Menu.....	64
	Slave Address Menu.....	65

Baud Rate Menu.....	65
Data Parity Menu.....	66
Data Bits Menu.....	66
Stats Menu.....	67
UPS Statistics Screen.....	67
Modbus Statistics Screen.....	67
MUCM Statistics Screen.....	68
System Menu.....	69
Port Test.....	69
<b>8 Software Installation.....</b>	<b>73</b>
Software Installation.....	73
Updating the Application in the MUCM.....	73
Updating the MUCM Firmware.....	78
Start QLOAD.EXE from Windows Start Menu:.....	78
<b>Appendix A Purchasing Options.....</b>	<b>81</b>

## Figures

Figure 1.1: Typical Configuration.....	8
Figure 2.1: Powering an MUCM in a 9900 UPS.....	10
Figure 2.2.: MUCM to 9-pin UPS RS-232 (MU1 Cable).....	11
Figure 2.3.: MUCM to 25-pin UPS RS-232 (MU17 Cable).....	11
Figure 2.4.: MUCM to 4-wire Modbus Slaves.....	12
Figure 2.5.: MUCM to 2-wire Modbus Slaves.....	12
Figure 2.6: Splash screen.....	13
Figure 2.7: Select UPS Type.....	13
Figure 2.8: Port 2 Configuration Menus.....	14
Figure 3.1: UPS Online.....	17
Figure 3.2: UPS Offline.....	17
Figure 3.3: Modbus Framing Errors.....	18
Figure 4.1: LonWorks Configuration.....	36
Figure 5.1: Example 1 Configuration.....	50
Figure 5.2: 4-wire RS-485 Example.....	51
Figure 5.3: 2-wire RS-485 Example.....	51
Figure 6.1: UPS Online and Offline.....	54
Figure 6.2: UPS Statistics Screen.....	54
Figure 6.3: NRDTOOL.EXE.....	55
Figure 6.4: Open Connection.....	56
Figure 6.5: Connected to Slave Address 254.....	57
Figure 7.1: Splash screen.....	60
Figure 7.2: Error Condition Examples.....	60
Figure 7.3: Main Menu screen.....	60
Figure 7.4: UPS Data Alarms Screen Examples.....	61
Figure 7.5: UPS Data Input Screen Examples.....	61

Figure 7.6: UPS Data Output Screen Examples.....	61
Figure 7.7: UPS Data Bypass Screen Examples.....	62
Figure 7.8: UPS Data Battery Screen Examples.....	62
Figure 7.9: UPS Data Modbus Register Value Screen Examples.....	62
Figure 7.10: UPS Configuration Screen.....	63
Figure 7.11: UPS Type Screen.....	63
Figure 7.12: Configure Port 2 Screen.....	64
Figure 7.13: Mode Screen.....	64
Figure 7.14: Slave Address Screen.....	65
Figure 7.15: Baud Rate Screen.....	65
Figure 7.16: Data Parity Screen.....	66
Figure 7.17: Data Bits Screen.....	66
Figure 7.18: Stats Screen.....	67
Figure 7.19: UPS Stats Screen.....	67
Figure 7.20: Modbus Stats Screen.....	68
Figure 7.21: MUCM Stats Screen.....	68
Figure 7.22: System Menu Screen.....	69
Figure 7.23: Port Test Screen.....	69
Figure 7.24:Port 1 RS-232 Loop Back Connector.....	70
Figure 7.25:Port 2 RS-485 Loop Back Connector.....	70
Figure 7.26: Port Test PASS Screen.....	70
Figure 7.27: Port Test FAIL Screens.....	71
Figure 8.1: Halt the Application.....	73
Figure 8.2: Halted Application.....	74
Figure 8.3: Connect MUCM Module to PC.....	74
Figure 8.4: QLOAD Application.....	75
Figure 8.5: QLOAD Progress.....	76
Figure 8.6: QLOAD Firmware Warning Dialog.....	76
Figure 8.7: Change Application Switch to Halt.....	77
Figure 8.8: Restart the Application.....	77
Figure 8.9: Connect MUCM Module to PC.....	78
Figure 8.10: Using QLOAD to update firmware.....	79
Figure 8.11: Restart the Application.....	79

## Tables

Table 2.1: MUCM Default Port Settings.....	12
Table 3.1: UPS Protocol List.....	18
Table 3.2: 2033C Register List (Battery).....	19
Table 3.3: 2033C Register List (Input).....	19
Table 3.4: 2033C Register List (Output).....	19
Table 3.5: 2033C Register List (Alarms).....	20
Table 3.6: 2033C Register List (UPS Setup).....	20
Table 3.7: 1100, 2033D, 7011A, 9800AD, 9800AE, 9900A, 9900B Register List (Battery).....	22
Table 3.8: 1100, 2033D, 7011A, 9800AD, 9800AE, 9900A, 9900B Register List (Input).....	23

Table 3.9: 1100, 2033D, 7011A, 9800AD, 9800AE, 9900A, 9900B Register List (Output).....	23
Table 3.10: 1100, 2033D, 7011A, 9800AD, 9800AE, 9900A, 9900B Register List (BYPASS).....	23
Table 3.11: 1100, 2033D, 7011A, 9800AD, 9800AE, 9900A, 9900B Register List (Alarms).....	24
Table 3.12: 1100, 2033D, 7011A, 9800AD, 9800AE, 9900A, 9900B Register List (UPS Setup).....	25
Table 3.13: 2033A, 9700 Register List (Battery).....	26
Table 3.14: 2033A, 9700 Register List (Input).....	27
Table 3.15: 2033A, 9700 Register List (Output).....	27
Table 3.16: 2033A, 9700 Register List (BYPASS).....	27
Table 3.17: 2033A, 9700 Register List (Alarms).....	28
Table 3.18: 2033A, 9700 Register List (Status).....	31
Table 3.19: Old 2033A Register List (Inverter Voltages).....	32
Table 3.20: Old 2033A Register List (Bypass Input Voltages).....	32
Table 3.21: Old 2033A Register List (Output Currents).....	33
Table 3.22: Old 2033A Register List (Battery).....	33
Table 3.23: Old 2033A Register List (Other).....	33
Table 3.24: Old 2033A Register List (Active Fault Codes).....	34
Table 4.1: 2033A (and 9700)Files.....	37
Table 4.2: 2033A, 9700 LonWorks Network Variable List (Battery).....	37
Table 4.3: 2033A, 9700 LonWorks Network Variable List (Input).....	37
Table 4.4: 2033A, 9700 LonWorks Network Variable List (Output).....	38
Table 4.5: 2033A, 9700 LonWorks Network Variable List (Bypass).....	38
Table 4.6: 2033A, 9700 LonWorks Network Variable List (Alarms).....	38
Table 4.7: 2033A, 9700 LonWorks Network Variable List (Status).....	42
Table 4.8: 2033C Files.....	43
Table 4.9: 2033C LonWorks Network Variable List (Battery).....	43
Table 4.10: 2033C LonWorks Network Variable List (Input).....	44
Table 4.11: 2033C LonWorks Network Variable List (Output).....	44
Table 4.12: 2033C LonWorks Network Variable List (Alarms).....	45
Table 4.13: 2033D, 7011A, 9800AD, 9900 Neuron Files.....	45
Table 4.14: 2033D, 7011A, 9800AD, 9900 LonWorks Network Variable List (Battery).....	46
Table 4.15: 2033D, 7011A, 9800AD, 9900 LonWorks Network Variable List (Input).....	46
Table 4.16: 2033D, 7011A, 9800AD, 9900 LonWorks Network Variable List (Output).....	46
Table 4.17: 2033D, 7011A, 9800AD, 9900 LonWorks Network Variable List (Bypass).....	47
Table 4.18: 2033D, 7011A, 9800AD, 9900 LonWorks Network Variable List (Alarms).....	47
Table 5.1: Example 1 Settings.....	49

---

# 1 Introduction

The Niobrara MUCM is an Modicon Momentum<sup>®</sup> compatible module that is capable of running an application for performing communication translations between serial protocols. This document covers an application that allows a Modbus serial master to gather data from a Mitsubishi Uninterruptible Power Supply (UPS).

Support is provided for Mitsubishi 1100, 2033A, 2033C, 2033D, 7011A, 9700, 9800AD, 9800AE, 9900A, 9900B and old 2033A models. UPS data is presented as Modbus Holding Registers (4x). Analog values are stored as 16bit integers and alarm values are stored as bits of 16-bit registers. The MUCM may be configured as a Modbus RTU (default) or Modbus ASCII slave. The Modbus Slave Address (default=1), baud rate (default=9600), data bits (default=8), and parity (default=NONE) may all be configured from the front panel.

The Niobrara LonWorks<sup>®</sup> tophat may be used to place the UPS data onto LonWorks.

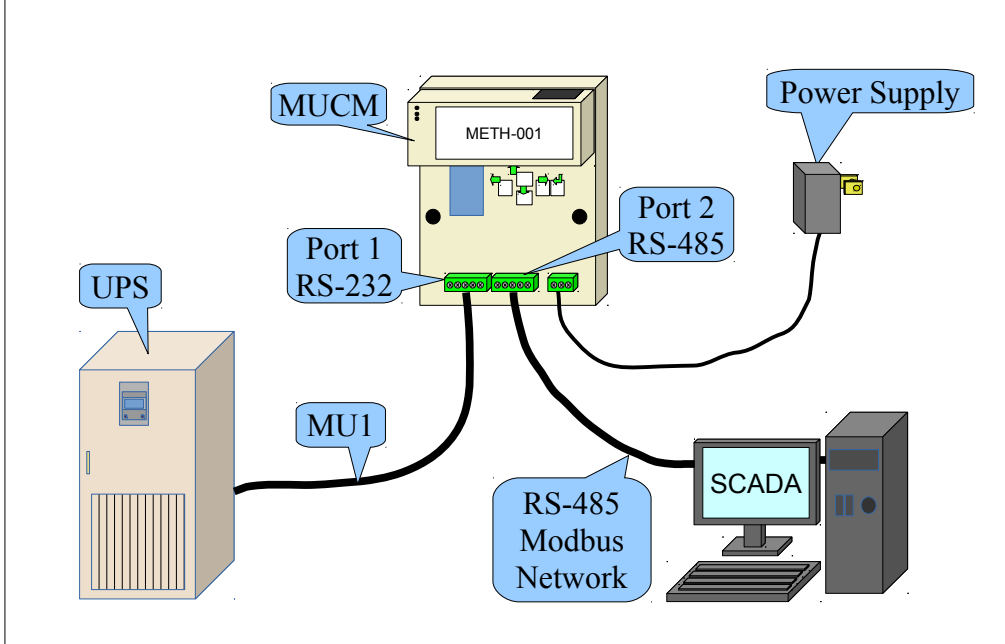
Port 1 of the MUCM is RS-232 and is to be connected to the UPS. The Niobrara MU1 cable is provided for the connection to the UPS 9-pin RS-232 port. The Niobrara MU17 cable or the MU1 with an SD013 adapter may be used to connect to a 25-pin port of the UPS. Port 2 of the MUCM is RS-485 and is to be connected to the Modbus network. The Niobrara SC912 cable is handy for testing the Modbus RS-485 connection from a PC.

The MUCM requires 24 VDC power supply and needs a minimum 6W.

When ordered as the MCP-104 kit contains:

- MUCM+302 - Preloaded with Mitsubishi application
- METH-001 - Momentum empty communications adapter enclosure.
- TR121ST - 110 VAC wall transformer for MUCM (no connector)
- MU1 - MUCM RS-232 port to PC COM: port cable; screw terminal to DB9S

Figure 1.1: Typical Configuration





---

## 2 Installation

Installation of the MUCM should go quickly, with the necessary materials. The following items are necessary:

- MUCM +302
- MU1 cable see Figure 2.2
- Power source for MUCM (use NR&D part TR121ST or available power)
- Cabling between MUCM and Modbus Master may be built or purchased
- Cabling between MUCM and UPS equipment may be built or purchased. The MU1 cable may be used to connect to the UPS 9-pin RS-232 port on models 2033C, 2033D, 7011, 9800AD, and 9900. The SD013 9-25 pin adapter may be used with the MU1 cable, or the MU17 cable may be used to connect the MUCM to the 25 pin port on Models 2033A and 9700.

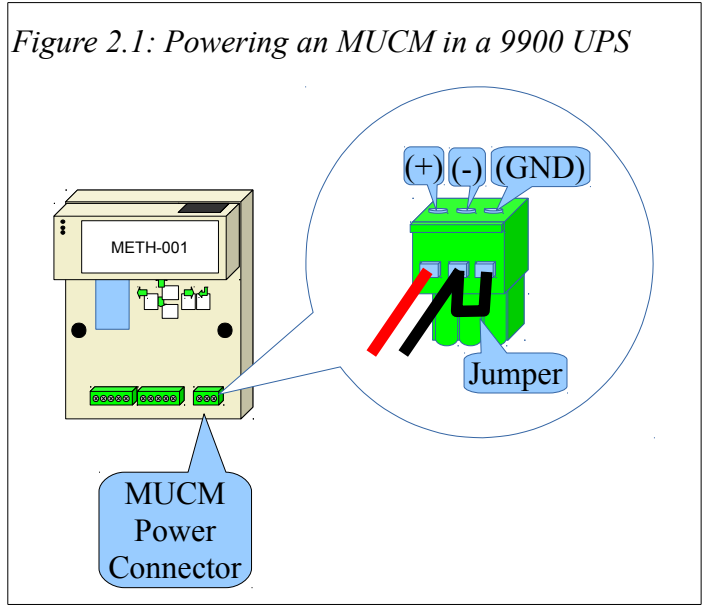
The following may be used:

- DIN rail for mounting

### ***Module Installation***

1. Mount the MUCM on a DIN rail, or mount as desired using screws through the two holes provided. The DIN rail or mounting screws should be Earth-grounded for the MUCM serial ports' transient suppression.
2. Supply power to the MUCM; The supplied NR&D's TR121ST may be used, or any available power source of minimum 6W 9-30 Volts DC.

**NOTICE:** Because the 9900 UPS is ungrounded, a jumper wire must be installed between the negative terminal of the power supply, and the case ground screw on the MUCM to ensure proper operation. See Figure 2.1.



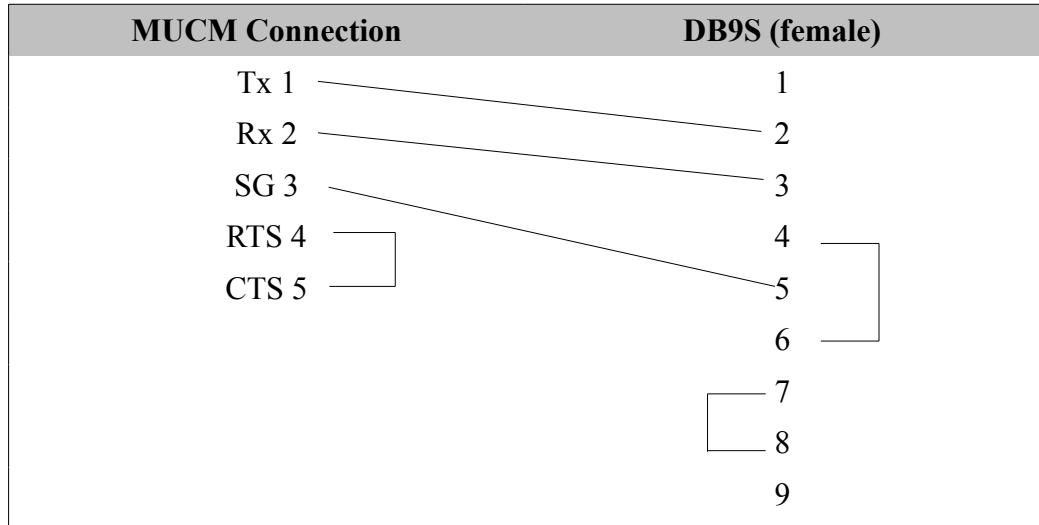
## **Serial Connections to the MUCM**

### **Port 1 to 9-pin UPS**

Port 1 of the MUCM is RS-232 so a simple 3-wire cable is required to connect to the UPS. In general, the UPS's Tx signal will connect to the MUCM's Rx, and the UPS's Rx signal will connect to the MUCM's Tx. Signal ground must run from the UPS to the MUCM, and each device will have its RTS and CTS handshaking pins shorted together.

Mitsubishi UPS models 2033C, 2033D, 7011, 9800AD, and 9900 use a standard 9-pin RS-232 serial port and thus the Niobrara MU1 cable may be used. For other standard connections, see the MUCM manual, or contact NR&D's technical support.

Figure 2.2.: MUCM to 9-pin UPS RS-232 (MU1 Cable)

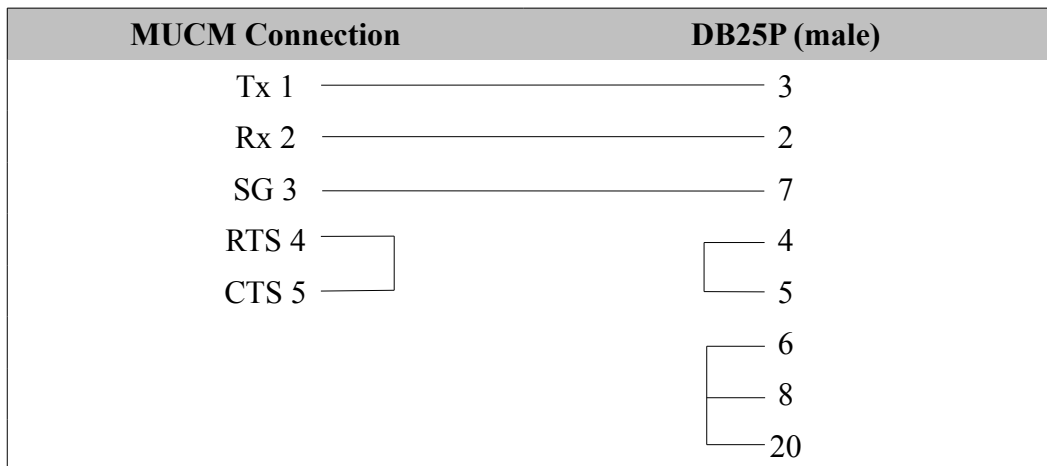


### Port 1 to 25-pin UPS

Port 1 of the MUCM is RS-232 so a simple 3-wire cable is required to connect to the UPS. In general, the UPS's Tx signal will connect to the MUCM's Rx, and the UPS's Rx signal will connect to the MUCM's Tx. Signal ground must run from the UPS to the MUCM, and each device will have its RTS and CTS handshaking pins shorted together.

Mitsubishi UPS models 2033A, and 9700 use a 25-pin RS-232 serial port and thus the Niobrara MU1 with the SD013 adapter or the MU17 cable may be used. For other standard connections, see the MUCM manual, or contact NR&D's technical support.

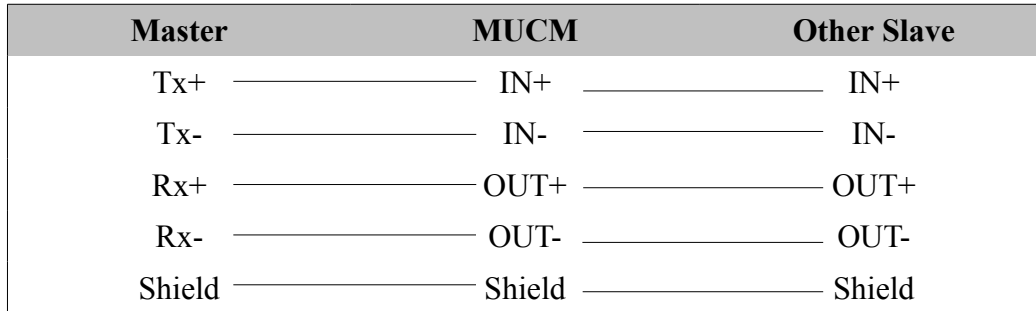
Figure 2.3.: MUCM to 25-pin UPS RS-232 (MU17 Cable)



### Port 2 to Modbus Network

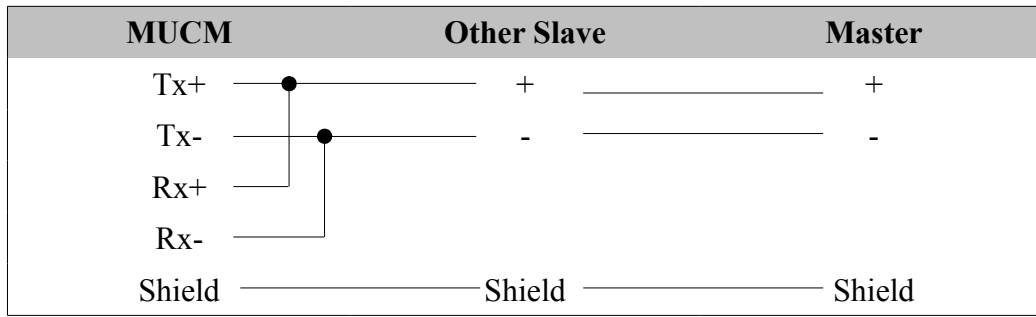
Port 2 of the MUCM is RS-422/485 so a simple 4-wire cable is required to connect to most Modbus equipment. Twisted pair cable should be used.

Figure 2.4.: MUCM to 4-wire Modbus Slaves



2-Wire RS-485 slaves are supported by the MUCM by jumpering the TX+ and RX+ together to make the (+) connection and the Tx- and Rx- together for the (-) connection.

Figure 2.5.: MUCM to 2-wire Modbus Slaves



### MUCM Application Configuration

Connect the UPS to MUCM port 1 and the Modbus Master to MUCM port 2. The default settings for the MUCM are shown in Table 2.1.

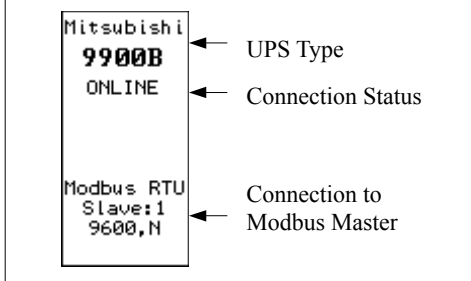
Table 2.1: MUCM Default Port Settings

Setting	Port 1	Port 2
Protocol Mode	9900B	Modbus RTU
Baud Rate	N/A	9600
Parity	N/A	None
Data Bits	N/A	8
Stop Bits	N/A	1
Modbus Slave Address	N/A	1

These settings may be modified by using the front panel and LCD screen on the MUCM. When the application starts it tries to communicate with the default USP. If the UPS responds to the queries Splash screen will look similar to Figure 2.6. This screen displays information about the UPS type and about the connection between the UPS and MUCM as well as the connection to the

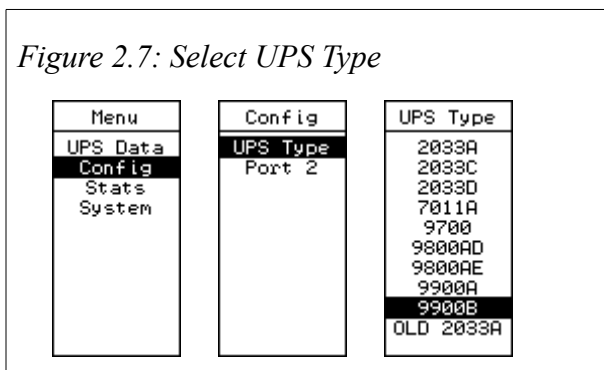
Modbus master on port 2.

Figure 2.6: Splash screen



Pressing the Up, Down or right arrow key will bring up the Main Menu. Use the up, down, right, and enter keys to select Config, UPS Type to select the UPS connected to the MUCM from the list.

Figure 2.7: Select UPS Type



To set up port 2 parameters use the up, down, right, and enter keys to select Menu, Config, Port 2 then select the Mode, Slave address, Baud rate, Parity, Data bits from the lists to match the settings of the Modbus master.

Figure 2.8: Port 2 Configuration Menus

<table border="1"> <tr><td>Menu</td></tr> <tr><td>UPS Data</td></tr> <tr><td><b>Config</b></td></tr> <tr><td>Stats</td></tr> <tr><td>System</td></tr> </table>	Menu	UPS Data	<b>Config</b>	Stats	System	<table border="1"> <tr><td>Config</td></tr> <tr><td>UPS Type</td></tr> <tr><td><b>Port 2</b></td></tr> </table>	Config	UPS Type	<b>Port 2</b>	<table border="1"> <tr><td>Port 2</td></tr> <tr><td>Modbus RTU</td></tr> <tr><td>Slave:1</td></tr> <tr><td>9600</td></tr> <tr><td>None</td></tr> <tr><td>8</td></tr> <tr><td>RS-485</td></tr> </table>	Port 2	Modbus RTU	Slave:1	9600	None	8	RS-485	<table border="1"> <tr><td>Mode</td></tr> <tr><td>Modbus RTU</td></tr> <tr><td>Mbus ASCII</td></tr> <tr><td>Debug</td></tr> </table>	Mode	Modbus RTU	Mbus ASCII	Debug							
Menu																													
UPS Data																													
<b>Config</b>																													
Stats																													
System																													
Config																													
UPS Type																													
<b>Port 2</b>																													
Port 2																													
Modbus RTU																													
Slave:1																													
9600																													
None																													
8																													
RS-485																													
Mode																													
Modbus RTU																													
Mbus ASCII																													
Debug																													
<table border="1"> <tr><td>Menu</td></tr> <tr><td>UPS Data</td></tr> <tr><td><b>Config</b></td></tr> <tr><td>Stats</td></tr> <tr><td>System</td></tr> </table>	Menu	UPS Data	<b>Config</b>	Stats	System	<table border="1"> <tr><td>Config</td></tr> <tr><td>UPS Type</td></tr> <tr><td><b>Port 2</b></td></tr> </table>	Config	UPS Type	<b>Port 2</b>	<table border="1"> <tr><td>Port 2</td></tr> <tr><td>Modbus RTU</td></tr> <tr><td>Slave:1</td></tr> <tr><td>9600</td></tr> <tr><td>None</td></tr> <tr><td>8</td></tr> <tr><td>RS-485</td></tr> </table>	Port 2	Modbus RTU	Slave:1	9600	None	8	RS-485	<table border="1"> <tr><td>Slave</td></tr> <tr><td><b>1</b></td></tr> <tr><td>2</td></tr> <tr><td>3</td></tr> <tr><td>4</td></tr> <tr><td>5</td></tr> <tr><td>6</td></tr> <tr><td>7</td></tr> <tr><td>8</td></tr> <tr><td>9</td></tr> <tr><td>10</td></tr> </table>	Slave	<b>1</b>	2	3	4	5	6	7	8	9	10
Menu																													
UPS Data																													
<b>Config</b>																													
Stats																													
System																													
Config																													
UPS Type																													
<b>Port 2</b>																													
Port 2																													
Modbus RTU																													
Slave:1																													
9600																													
None																													
8																													
RS-485																													
Slave																													
<b>1</b>																													
2																													
3																													
4																													
5																													
6																													
7																													
8																													
9																													
10																													
<table border="1"> <tr><td>Menu</td></tr> <tr><td>UPS Data</td></tr> <tr><td><b>Config</b></td></tr> <tr><td>Stats</td></tr> <tr><td>System</td></tr> </table>	Menu	UPS Data	<b>Config</b>	Stats	System	<table border="1"> <tr><td>Config</td></tr> <tr><td>UPS Type</td></tr> <tr><td><b>Port 2</b></td></tr> </table>	Config	UPS Type	<b>Port 2</b>	<table border="1"> <tr><td>Port 2</td></tr> <tr><td>Modbus RTU</td></tr> <tr><td>Slave:1</td></tr> <tr><td><b>9600</b></td></tr> <tr><td>None</td></tr> <tr><td>8</td></tr> <tr><td>RS-485</td></tr> </table>	Port 2	Modbus RTU	Slave:1	<b>9600</b>	None	8	RS-485	<table border="1"> <tr><td>Baud</td></tr> <tr><td>1200</td></tr> <tr><td>2400</td></tr> <tr><td>4800</td></tr> <tr><td><b>9600</b></td></tr> <tr><td>19200</td></tr> <tr><td>38400</td></tr> </table>	Baud	1200	2400	4800	<b>9600</b>	19200	38400				
Menu																													
UPS Data																													
<b>Config</b>																													
Stats																													
System																													
Config																													
UPS Type																													
<b>Port 2</b>																													
Port 2																													
Modbus RTU																													
Slave:1																													
<b>9600</b>																													
None																													
8																													
RS-485																													
Baud																													
1200																													
2400																													
4800																													
<b>9600</b>																													
19200																													
38400																													
<table border="1"> <tr><td>Menu</td></tr> <tr><td>UPS Data</td></tr> <tr><td><b>Config</b></td></tr> <tr><td>Stats</td></tr> <tr><td>System</td></tr> </table>	Menu	UPS Data	<b>Config</b>	Stats	System	<table border="1"> <tr><td>Config</td></tr> <tr><td>UPS Type</td></tr> <tr><td><b>Port 2</b></td></tr> </table>	Config	UPS Type	<b>Port 2</b>	<table border="1"> <tr><td>Port 2</td></tr> <tr><td>Modbus RTU</td></tr> <tr><td>Slave:1</td></tr> <tr><td>9600</td></tr> <tr><td><b>None</b></td></tr> <tr><td>8</td></tr> <tr><td>RS-485</td></tr> </table>	Port 2	Modbus RTU	Slave:1	9600	<b>None</b>	8	RS-485	<table border="1"> <tr><td>Parity</td></tr> <tr><td><b>None</b></td></tr> <tr><td>Odd</td></tr> <tr><td>Even</td></tr> </table>	Parity	<b>None</b>	Odd	Even							
Menu																													
UPS Data																													
<b>Config</b>																													
Stats																													
System																													
Config																													
UPS Type																													
<b>Port 2</b>																													
Port 2																													
Modbus RTU																													
Slave:1																													
9600																													
<b>None</b>																													
8																													
RS-485																													
Parity																													
<b>None</b>																													
Odd																													
Even																													
<table border="1"> <tr><td>Menu</td></tr> <tr><td>UPS Data</td></tr> <tr><td><b>Config</b></td></tr> <tr><td>Stats</td></tr> <tr><td>System</td></tr> </table>	Menu	UPS Data	<b>Config</b>	Stats	System	<table border="1"> <tr><td>Config</td></tr> <tr><td>UPS Type</td></tr> <tr><td><b>Port 2</b></td></tr> </table>	Config	UPS Type	<b>Port 2</b>	<table border="1"> <tr><td>Port 2</td></tr> <tr><td>Modbus RTU</td></tr> <tr><td>Slave:1</td></tr> <tr><td>9600</td></tr> <tr><td>None</td></tr> <tr><td><b>8</b></td></tr> <tr><td>RS-485</td></tr> </table>	Port 2	Modbus RTU	Slave:1	9600	None	<b>8</b>	RS-485	<table border="1"> <tr><td>Data Bits</td></tr> <tr><td>7</td></tr> <tr><td><b>8</b></td></tr> </table>	Data Bits	7	<b>8</b>								
Menu																													
UPS Data																													
<b>Config</b>																													
Stats																													
System																													
Config																													
UPS Type																													
<b>Port 2</b>																													
Port 2																													
Modbus RTU																													
Slave:1																													
9600																													
None																													
<b>8</b>																													
RS-485																													
Data Bits																													
7																													
<b>8</b>																													

The MUCM will answer Modbus RTU requests on its RS-485 port that are directed to its Modbus Slave Address only if it can communicate with the UPS. If the MUCM is not able to communicate with the UPS then it will not respond to queries to the slave address.

---

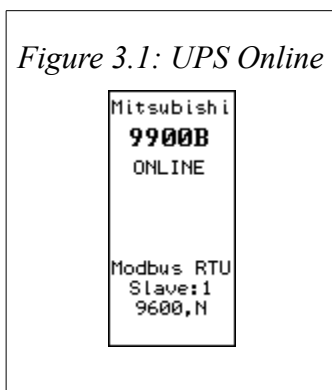
### 3 Modbus Operation

The Mitsubishi MUCM application uses Port 2 for Modbus communication. Port 2 is RS-485 and may be connected as a 4-wire multidrop slave or 2-wire multidrop slave. By default, Port 2 is set for Modbus RTU Slave, 9600 baud, 8 data bits, NONE parity, and Slave Address 1.

The MUCM will always answer Modbus messages directed to slave address 255 or 254.

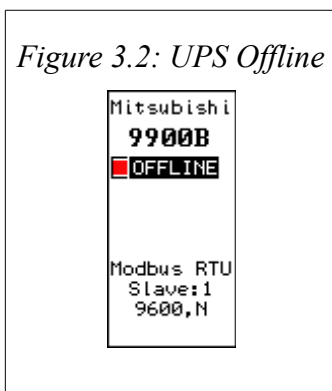
The MUCM will briefly light the yellow Rx LED on port 2 when any message is received on the RS-485 port. If the message is intended for the MUCM then the yellow Tx LED on port 2 light will come on as the MUCM replies if the UPS is online.

*Figure 3.1: UPS Online*



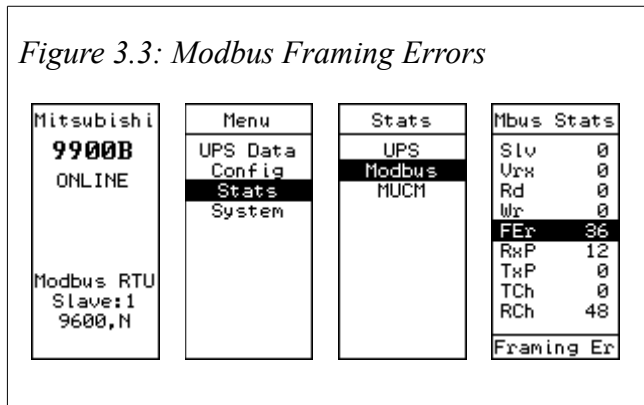
If the UPS is not responding to the MUCM then the MUCM will not respond and an OFFLINE box will be displayed beside a red LED on the LCD.

*Figure 3.2: UPS Offline*





If a parity or framing error is detected in the received message then the framing error statistic will begin counting up on the Modbus statistics page.



## UPS Device Types

The following Mitsubishi devices are supported by the MUCM. The device type must be set in the setup from the front panel of the MUCM.

*Table 3.1: UPS Protocol List*

UPS Model	Protocol
1100	SEC
2033A	MIT
2033C and 2033D	SEC
7011A	SEC
9700 Series	MIT
9800AD and 9800AE	SEC
9900A and 9900B	SEC
“Old” 2033A	Pre-Version E MIT

## 2033C Register List

The data from the UPS is presented as Holding Registers (4x). Registers 1 through 66 are read only 16-bit unsigned integers that provide data on the UPS System, Battery, Input, Output, and Bypass circuits. Several data points have an implied decimal place to give a greater precision for the reading. For example, register 16 indicates the frequency of Input Line A times 0.1Hz. A value of 599 indicates a frequency of 59.9Hz.

The mapping in the following tables provides data for 3-phase models. UPS models that provide fewer phases will have the unused values set to zero. The number of phases may be checked by reading registers 500 through 502.

*Table 3.2: 2033C Register List (Battery)*

Register	Measurement	Notes
4x0001	UPS Device Type	Integer Value 1 = SEC
4x0002	Battery Condition	Integer Value 0 = Good 1 = Weak 2 = Replace
4x0003	Battery Status	Integer Value 0 = OK 1 = Low 2 = Depleted
4x0004	Battery Charge	Integer Value 0 = Floating 1 = Charging 2 = Resting 3 = Discharging
4x0005	Seconds on Battery	Seconds
4x0006	Estimated Minutes Remaining	Minutes
4x0007	% Battery Charge Left	0-100%

*Table 3.3: 2033C Register List (Input)*

Register	Measurement	Notes
4x0014	Input Line Bads	Count
4x0016	Input Frequency	x0.1 Hz
4x0022	Input Voltage	x0.1 VAC
4x0025	Input Current	x0.1 A
4x0029	Input Power	W

*Table 3.4: 2033C Register List (Output)*

Register	Measurement	Notes
4x0032	Output Source	Integer Value 0 = Normal 1 = On Battery 2 = On Bypass 3 = Reducing 4 = Boosting 5 = Other
4x0036	Output Voltage	x0.1VAC
4x0039	Output Current	x0.1 A
4x0045	Output Power	W
4x0048	Output % Load	0-100%
4x0051	Output Frequency	x0.1 Hz

The Alarms are mapped as bits in registers. If the alarm is active then its bit will be set. The bits are labeled in IEC format where bit 0 is the LSB and 15 is the MSB.

Table 3.5: 2033C Register List (Alarms)

Register	Bit	Description
4x0067	0	Temperature Alarm
	1	Input Bad Alarm
	2	Output Bad Alarm
	3	Overload Alarm
	4	Bypass Bad Alarm
	5	Output Off Alarm
	6	UPS Shutdown Alarm
	7	Charger Failure Alarm
	8	System Off Alarm
	9	Fan Failure Alarm
	10	Fuse Failure Alarm
	11	General Fault Alarm
	12	Awaiting Power Alarm
	13	Shutdown Pending Alarm
	14	Shutdown Imminent Alarm
15	Reserved	

**Example:**  
 Decimal value = 96  
 Binary value = 0000 0000 0110 0000  
 Alarm Bit 5 and 6 are ON all others are OFF

The UPS configuration is stored in registers 500 through 652. Some registers are read only and some are writable. Care must be exercised on writing configuration parameters. The values are sent to the UPS upon reception of a Modbus write to the MUCM, therefore, it is important to only send a write when the configuration needs to be changed. Do not configure the Master to continuously send writes to the MUCM.

Table 3.6: 2033C Register List (UPS Setup)

Register	R/W	Measurement	Notes
4x0499	R	Read Only Bitmap of pending writes to UPS	Bit 0 = Auto Reboot [503] Bit 1 = Nominal Setting [504-517] Bit 2 = Shutdown After Delay[518] Bit 3 = Reboot with Duration[519] Bit 4 = Action taken at Shutdown[520] Bit 5 = Startup After Delay[521] Bit 6 = Test[522] Bit 7 = UPS Baud Rate[523] Bit 8 = UPS Identification[524-555]
4x0500	R	Number of Input Lines	1-3
4x0501	R	Number of Output Lines	1-3

**Example:**  
 Decimal value = 20  
 Binary value = 0001 0100  
 Pending Write Bit 2 and 4 are ON all others are OFF

Register	R/W	Measurement	Notes
4x0504	R W	Nominal Input Voltage	Volts
4x0505	R W	Nominal Input Frequency	x0.1 Hz
4x0506	R W	Nominal Output Voltage	Volts
4x0507	R W	Nominal Output Frequency	x0.1 Hz
4x0508	R W	Nominal VA Rating	VA
4x0509	R W	Nominal Output Power	W
4x0510	R W	Low Battery Time	Minutes
4x0511	R W	Audible Alarm	Integer Value 1 = Disabled 2 = Enabled 3 = Muted 4 = Disabled until Low Battery
4x0512	R W	Low Voltage Transfer Point	Volts
4x0513	R W	High Voltage Transfer Point	Volts
4x0514	R W	Battery Installed Month	1-12
4x0515	R W	Battery Installed Day	1-31
4x0516	R W	Battery Installed Year	xxxx
4x0517	R W	Nominal Battery Life	Days
4x0518	R W	Shutdown After Delay	-1 = Abort 0 = Immediate > 0 = Seconds until shutdown
4x0519	R W	Reboot with Duration	> 0 = Seconds after shutdown
4x0520	R W	Action Taken at Shutdown	1 = UPS Output OFF 2 = UPS System OFF
4x0521	R W	Startup After Delay	-1 = Abort 0 = Immediate > 0 = Seconds until shutdown
4x0522	R W	Test	-1 = Abort 0 = No Effect 1 = General Test 2 = Battery Test 3 = Deep Test
4x0523	R W	UPS Baud Rate	1200, 2400, 4800, 9600, or 19200

Register	R/W	Measurement	Notes
4x0524 - 4x0555	R W	Identification String	Packed ASCII
4x0556	R	Test Results	Integer Value 0 = No Tests Performed 1 = Test Passed 2 = Test In Progress 3 = General Test Failed 4 = Battery Test Failed 5 = Deep Test Failed
4x0557 - 4x0588	R	Test Results String	Packed ASCII
4x0589 - 4x0604	R	UPS Manufacturer String	Packed ASCII
4x0605 - 4x0636	R	UPS Model String	Packed ASCII
4x0637 - 4x0652	R	UPS Software Version String	Packed ASCII

## 1100, 2033D, 7011A, 9800AD, 9800AE, 9900A, and 9900B Register List

The data from the UPS is presented as Holding Registers (4x). Registers 1 through 66 are read only 16-bit unsigned integers that provide data on the UPS System, Battery, Input, Output, and Bypass circuits. Several data points have an implied decimal place to give a greater precision for the reading. For example, register 17 indicates the frequency of Input Line A times 0.1. A value of 599 indicates a frequency of 59.9Hz.

The mapping in the following tables provides data for 3-phase models. UPS models that provide fewer phases will have the unused values set to zero. The number of phases may be checked by reading registers 500 through 502.

*Table 3.7: 1100, 2033D, 7011A, 9800AD, 9800AE, 9900A, 9900B Register List (Battery)*

Register	Measurement	Notes
4x0001	UPS Device Type	Integer Value 1 = SEC
4x0003	Battery Status	Integer Value 0 = OK 1 = Low 2 = Depleted

Register	Measurement	Notes
4x0004	Battery Charge	Integer Value 0 = Floating 1 = Charging 2 = Resting 3 = Discharging
4x0005	Seconds on Battery	Seconds
4x0007	% Battery Charge Left	0-100%
4x0008	Battery Voltage	x0.1 VAC

*Table 3.8: 1100, 2033D, 7011A, 9800AD, 9800AE, 9900A, 9900B Register List (Input)*

Register	Measurement	Notes
4x0014	Input Line Bads	Count
4x0016	Input Frequency	x0.1 Hz
4x0022	Input Voltage	x0.1 VAC

*Table 3.9: 1100, 2033D, 7011A, 9800AD, 9800AE, 9900A, 9900B Register List (Output)*

Register	Measurement	Notes
4x0032	Output Source	Integer Value 0 = Normal 1 = On Battery 2 = On Bypass 3 = Reducing 4 = Boosting 5 = Other
4x0036	Output Voltage Phase A-B	x0.1VAC
4x0037	Output Voltage Phase B-C	x0.1VAC
4x0038	Output Voltage Phase C-A	x0.1VAC
4x0039	Output Current Phase A	x0.1 A
4x0040	Output Current Phase B	x0.1 A
4x0041	Output Current Phase C	x0.1 A
4x0045	Output Power	W
4x0048	Output % Load Phase A	0-100%
4x0049	Output % Load Phase B	0-100%
4x0050	Output % Load Phase C	0-100%
4x0051	Output Frequency	x0.1 Hz

*Table 3.10: 1100, 2033D, 7011A, 9800AD, 9800AE, 9900A, 9900B Register List (BYPASS)*

Register	Measurement	Notes
4x0057	Bypass Voltage Phase A-B	x0.1 VAC

Register	Measurement	Notes
4x0058	Bypass Voltage Phase B-C	x0.1VAC
4x0059	Bypass Voltage Phase C-A	x0.1VAC
4x0060	Bypass Current Phase A	x0.1A
4x0061	Bypass Current Phase B	x0.1 A
4x0062	Bypass Current Phase C	x0.1 A
4x0063	Bypass Power	W
4x0066	Bypass Frequency	x0.1 Hz

The Alarms are mapped as bits in registers. If the alarm is active then its bit will be set. The bits are labeled in IEC format where bit 0 is the LSB and 15 is the MSB.

*Table 3.11: 1100, 2033D, 7011A, 9800AD, 9800AE, 9900A, 9900B Register List (Alarms)*

Register	Bit	Description
4x0067	0	Temperature Alarm
	1	Input Bad Alarm
	2	Output Bad Alarm
	3	Overload Alarm
	4	Bypass Bad Alarm
	5	Output Off Alarm
	6	UPS Shutdown Alarm
	7	Charger Failure Alarm
	8	System Off Alarm
	9	Fan Failure Alarm
	10	Fuse Failure Alarm
	11	General Fault Alarm
	12	Awaiting Power Alarm
	13	Shutdown Pending Alarm
	14	Shutdown Imminent Alarm
15	Reserved	

**Example:**

Decimal value = 96

Binary value = 0000 0000 0110 0000

Alarm Bit 5 and 6 are ON all others are OFF

The UPS configuration is stored in registers 500 through 652. Some registers are read only and some are writeable. Care must be exercised on writing configuration parameters. The values are sent to the UPS upon reception of a Modbus write to the MUCM, therefore, it is important to only send a write when the configuration needs to be changed. Do not configure the Master to continuously send writes to the MUCM.

Table 3.12: 1100, 2033D, 7011A, 9800AD, 9800AE, 9900A, 9900B Register List (UPS Setup)

Register	R/W	Measurement	Notes
4x0499	R	Read Only Bitmap of pending writes to UPS	Bit 0 = Auto Reboot [503] Bit 1 = Nominal Setting [504-517] Bit 2 = Shutdown After Delay[518] Bit 3 = Reboot with Duration[519] Bit 4 = Action taken at Shutdown[520] Bit 5 = Startup After Delay[521] Bit 6 = Test[522] Bit 7 = UPS Baud Rate[523] Bit 8 = UPS Identification[524-555]
4x0500	R	Number of Input Lines	1-3
4x0501	R	Number of Output Lines	1-3
4x0502	R	Number of Bypass Lines	0-3
4x0504	RW	Nominal Input Voltage	Volts
4x0505	RW	Nominal Input Frequency	x0.1 Hz
4x0506	RW	Nominal Output Voltage	Volts
4x0507	RW	Nominal Output Frequency	x0.1 Hz
4x0508	RW	Nominal VA Rating	VA
4x0509	RW	Nominal Output Power	W
4x0511	RW	Audible Alarm	Integer Value 1 = Disabled 2 = Enabled 3 = Muted 4 = Disabled until Low Battery
4x0514	RW	Battery Installed Month	1-12
4x0515	RW	Battery Installed Day	1-31
4x0516	RW	Battery Installed Year	xxxx
4x0520	RW	Action Taken at Shutdown	1 = UPS Output OFF 2 = UPS System OFF
4x0522	RW	Test	-1 = Abort 0 = No Effect 1 = General Test 2 = Battery Test 3 = Deep Test
4x0523	RW	UPS Baud Rate	1200, 2400, 4800, 9600, or 19200

**Example:**  
Decimal value = 20  
Binary value = 0001 0100  
Pending Write Bit 2 and 4 are ON all others are OFF



Register	R/W	Measurement	Notes
4x0524 - 4x0555	RW	Identification String	Packed ASCII
4x0556	R	Test Results	Integer Value 0 = No Tests Performed 1 = Test Passed 2 = Test In Progress 3 = General Test Failed 4 = Battery Test Failed 5 = Deep Test Failed
4x0557 - 4x0588	R	Test Results String	Packed ASCII
4x0589 - 4x0604	R	UPS Manufacturer String	Packed ASCII
4x0605 - 4x0636	R	UPS Model String	Packed ASCII
4x0637 - 4x0652	R	UPS Software Version String	Packed ASCII

## 2033A and 9700 Register List

The data from the UPS is presented as Holding Registers (4x). Registers 1 through 66 are read only 16-bit unsigned integers that provide data on the UPS System, Battery, Input, Output, and Bypass circuits. Several data points have an implied decimal place to give a greater precision for the reading. For example, register 15 indicates the frequency of Input times 0.1. A value of 599 indicates a frequency of 59.9Hz.

*Table 3.13: 2033A, 9700 Register List (Battery)*

Register	Measurement	Notes
4x0001	UPS Device Type	Integer Value 2 = MIT
4x0007	% Battery Charge Left	0-100%
4x0008	Battery Voltage	x0.1 VDC
4x0009	Battery Current	x0.1 A
4x0011	Discharge Time	Hours
4x0012	Discharge Time	Minutes
4x0013	Discharge Time	Seconds

*Table 3.14: 2033A, 9700 Register List (Input)*

Register	Measurement	Notes
4x0014	Input Line Bads	Count
4x0015	Input Frequency	x0.1 Hz
4x0019	Input Voltage Phase A-B	x0.1 VAC
4x0020	Input Voltage Phase B-C	x0.1 VAC
4x0021	Input Voltage Phase C-A	x0.1 VAC
4x0022	Input Voltage Phase A-N	x0.1 VAC
4x0023	Input Voltage Phase B-N	x0.1 VAC
4x0024	Input Voltage Phase C-N	x0.1 VAC
4x0025	Input Current Phase A	x1 A
4x0026	Input Current Phase B	x1 A
4x0027	Input Current Phase C	x1 A

*Table 3.15: 2033A, 9700 Register List (Output)*

Register	Measurement	Notes
4x0033	Output Voltage Phase A-B	x0.1 VAC
4x0034	Output Voltage Phase B-C	x0.1 VAC
4x0035	Output Voltage Phase C-A	x0.1 VAC
4x0036	Output Voltage Phase A-N	x0.1 VAC
4x0037	Output Voltage Phase B-N	x0.1 VAC
4x0038	Output Voltage Phase C-N	x0.1 VAC
4x0039	Output Current Phase A	x1 A
4x0040	Output Current Phase B	x1 A
4x0041	Output Current Phase C	x1 A
4x0042	Output Peak Current Phase A	x1 A
4x0043	Output Peak Current Phase B	x1 A
4x0044	Output Peak Current Phase C	x1 A
4x0051	Output Frequency	x0.1 Hz
4x0052	Output Power	x0.1 W
4x0053	Output Power Factor	x0.01 %
4x0092	Output Current Phase N	x0.1 A

*Table 3.16: 2033A, 9700 Register List (BYPASS)*

Register	Measurement	Notes
4x0054	Bypass Voltage Phase A-B	x0.1 VAC
4x0055	Bypass Voltage Phase B-C	x0.1 VAC
4x0056	Bypass Voltage Phase C-A	x0.1 VAC
4x0057	Bypass Voltage Phase A-N	x0.1 VAC

Register	Measurement	Notes
4x0058	Bypass Voltage Phase B-N	x0.1VAC
4x0059	Bypass Voltage Phase C-N	x0.1VAC
4x0066	Bypass Frequency	x0.1 Hz

The Alarms are mapped as bits in registers. If the alarm is active then its bit will be set. The bits are labeled in IEC format where bit 0 is the LSB and 15 is the MSB. Unused bits are forced to zero.

Table 3.17: 2033A, 9700 Register List (Alarms)

Register	Bit	Code	Description
4x0068 Fault 1 (Bits 0-15)	1	UF007	Converter Input Current Sensor Abnormal
	2	UF105	DC Voltage Sensor Circuit Abnormal
	5	UF102	DC Undervoltage
	6	UF103	DC Overvoltage
	11	UF216	Inverter Output Current Sensor Abnormal
	12	UF201	Inverter Output Overvoltage +15%
	13	UF202	Inverter Output Undervoltage -15%
4x0069 Fault 1 (Bits 16-31)	0	UF306	UPS Control Power Circuit Error
	3	UF301	UPS Control Microprocessor Circuit Error
	5	UF305	UPS Control Circuit Error
	10	UF203	Inverter Output Overcurrent
	12	UF302	UPS Control Microprocessor Circuit Error
	13	UF303	UPS Control Microprocessor Circuit Error
	15	UF304	UPS Control Microprocessor Circuit Error
4x0070 Fault 2 (Bits 0-15)	2	UF216	Sensor Abnormal
4x0071 Fault 2 (Bits 16-31)	None	None	Reserved, No Alarms
4x0072 Fault 3 (Bits 0-15)	0	UF003	Converter Abnormal
	1	UF212	Fan Power Source Abnormal
	2	UF107	CB2 Abnormal
	3	UF214	Cooling Fan Thermal Relay Abnormal
	5	UF213	Inverter or Converter Over Temperature
	9	UF307	UPS Control Circuit Error
	11	UF209	52C Abnormal (Not Closed)
	12	UF210	52C Abnormal (Not Open)
	13	UF106	DC Capacitor Abnormal
15	UF255	52C Abnormal	
4x0073	3	UF309	Inverter Output Voltage Sensed before 52C Closed

Register	Bit	Code	Description
Fault 3 (Bits 16-31)	4	UF401	52S Abnormal (Not Closed or Closed without command)
	5	UF402	52S Abnormal (Not Opened or Open without command)
	6	UF215	Frequent Overload
4x0074 Fault 4 (Bits 0-15)	0	UF053	Input Contactor CB1 not Open under correct sequence
	1	UF052	Input Circuit Breaker CB1 Tripped
	2	UF257	52C Abnormal, did NOT Open after manual transfer to bypass
	3	UF451	52S Abnormal NOT Closed, or closed with no manual transfer command
	4	UF153	CB2 DC Circuit Breaker Tripped
	5	UF154	CB2 Abnormal
	9	UF158	Battery Liquid Level Low
	10	UF157	Battery Over Temperature
	11	UF156	CB2 Tripped (after prolonged battery over temperature 2 Hr)
	13	UF256	Output Voltage Abnormal (outside +/- 5%)
	15	UF352	Control Power Supply Abnormal
4x0075 Fault 4 (Bits 16-31)	0	UF159	DC Ground Fault
	2	UF160	DC Circuit Sensor Abnormal
	3	UF351	DC Control Fuse Blown
	4	UF151	DC Voltage Abnormal, DC Buss does not return to Float after power restored (24 Hr)
	5	UF152	DC Voltage Abnormal, DC Buss does not return to Equalize after power restored (24 Hr)
	9	UF162	DC Circuit Abnormal
	11	UF356	UPS Control Circuit Error
	12	UF357	“Inverter Start” Switch Abnormal
	13	UF358	“Inverter Stop” Switch Abnormal
	14	UF359	“Inverter Operation” Switch Abnormal
4x0076 Fault 5 (Bits 0-15)	0	UF255	52C Abnormal, Opened during Inverter Load Supply
	2	UF355	UPS Control Circuit Error
4x0077 Fault 5 (Bits 16-31)	None	None	Reserved, No Alarms
4x0078 Fault 6 (Bits 0-15)	1	UA802	AC Input Frequency Out of Range
4x0079 Fault 6 (Bits 16-31)	None	None	Reserved, No Alarms
4x0080 Fault 7 (Bits 0-15)	0	UF056	Converter Input Current Overload
	1	UF058	Cooling Fan Abnormal (Converter Circuit)
	2	UF057	Converter Over temperature

Register	Bit	Code	Description
	3	UF362	UPS Control Circuit Error
	4	UF161	CB2 Tripped (DC Voltage Abnormal) DC Buss does not return to Float after power restored (48 Hr)
	5	UF254	88C Abnormal – Fan AC Source Abnormal during Inverter Operation
	6	UF059	Converter Abnormal, Preliminary Charge Impossible
	7	UF060	Converter Abnormal
	8	UF363	Voltage Adjust Error
	9	UF258	Frequent Overload
4x0081 Fault 7 (Bits 16-31)	8	UF806	Inverter Overload > 100%
	9	UF807	Inverter Overload > 110%
	10	UF808	Inverter Overload > 125%
	11	UF809	Inverter Overload > 150%
	12	UF810	Inverter Overload, Momentary Overcurrent while load powered by inverter
	13	UF836	Converter Overload
4x0082 Fault 8 (Bits 0-15)	0	UA823	CB1 OFF, AC Input Contactor OPEN
	1	UA824	CB2 OFF, DC Contactor OPEN
	2	UA826	CB101 OFF, Control Breaker Opened During Inverter Load Supply.
	5	UA819	Remote Start Button Abnormal
	6	UA820	Remote Stop button Abnormal
	7	UA812	Bypass Voltage Out of Range +20%
	8	UA817	Emergency Stop Activated
	9	UA827	52C Not Permitted, Transfer Permitted switch open
	10	UA830	AC Input Undervoltage
	11	None	Manual Bypass Switch ON
	12	UA803	AC Input Phase Rotation Error
	13	UA805	Ambient Temperature Abnormal HIGH
	14	UA804	Battery DC Precharge Circuit Abnormal
	15	UA801	AC Input Voltage Out of Range Fell below 18% threshold.
	4x0083 Fault 8 (Bits 16-31)	0	UA811
1		None	Transfer Failure (Load Stop)
2		UA813	Bypass Phase Rotation Error
3		UA814	Bypass Frequency Out of Range
4		UA816	Extended Bypass Operation (10 minutes)
5		UA831	Emergency Bypass Switch ON
6		UA822	Generator Operation (Transfer to Bypass not permitted)
8		UA832	Interrupted Transfer to Bypass
9		UA821	UPS Stopped (Transfer Inhibited, Bypass Voltage out of range)
10		UA835	UPS Stopped (Transfer Inhibited, Inverter Asynchronous)

Register	Bit	Code	Description
	11	UA804	Battery Abnormal

Table 3.18: 2033A, 9700 Register List (Status)

Register	Bit	Description
4x0084 Status 1 (Bits 0-15)	0	Inverter is operating and powering the load
	1	Ex. Alarm, Minor Fault
	2	Inverter Running
	3	Inverter S/S, Inverter is Started from Local or Remote
	4	Battery Operation 1, 3 minute alarm time delay after battery backup
	5	Battery Low Voltage, near depletion due to prolonged AC Fail
	6	Overload, UPS Output Capacity Exceeded
	7	Overload, (Level Reached)
	8	Enable to Remote Operation
	9	Remote Operation
	10	Battery Depletion, Shutdown Imminent
	11	Battery Abnormal, Over temperature or Low Liquid Level
	12	Converter Operation, 1=Running
	13	Battery Operation 2, UPS in Battery Backup Mode
	14	CB1 1=Closed
15	CB2 1=Closed	
4x0085 Status 1 (Bits 16-31)	0	Converter is operating and supplying Inverter
	1	Battery Operation 3, No alarm time delay after battery backup initiated
	2	52C 1=Closed
	3	AC Input Abnormal, Voltage or Frequency out of range
	4	Equalize Charge, UPS in Equalize Mode
	5	Output Overload, (Inverter Stop)
	6	Test Mode
	7	Output Switch Abnormal, 52S or 52C Abnormal
	8	Battery Charge
4x0086 Status 2 (Bits 0-15)	0	CB1 Alarm
	1	CB2 Alarm
	2	52C Alarm
4x0087 Status 2 (Bits 16-31)	None	Reserved
4x0088 Status 3 (Bits 0-15)	0	Synchronism, Inverter is synchronized to external source
	1	Asynchronism, Inverter is in the free running mode
	2	Voltage Equalize Answer, DC Voltage reached equalizing voltage level
	5	52S 1=Closed
	6	CB3 1=Closed

Register	Bit	Description
	7	Bypass Operation, Load powered via static Bypass Line
	8	Bypass Input Abnormal, Voltage or Frequency Out of Range
	10	Bypass Abnormal
	12	Synchronism 2
	13	Load Supply, Load powered by UPS (Inverter or Bypass)
	14	Generator Operation, 1=UPS on Generator
4x0089 Status 3 (Bits 16-31)	None	Reserved
4x0090 EX Status (Bits 0-15)	0	Direction of Battery Current (1=Discharge, 0=Charging)
	1	Battery Floating
	2	Input Power Failure Detection
	3	Input Power Failure
4x0091 EX Status (Bits 16-31)	None	Reserved

## "Old" 2033A Register List

Versions 12Jun09 and later of this program support a version of the 2033A that does not use the standard Mitsubishi protocol. The current information available suggests that the communication board will be something previous to Version E that use this older protocol. The data from the UPS is presented as Holding Registers (4x). Registers 1 through 27 are read only 16-bit unsigned integers that provide data on the UPS System, Battery, Input, Output, and Bypass circuits. Several data points have an implied decimal place to give a greater precision for the reading. For example, register 25 indicates the frequency of Input Bypass times 0.1. A value of 599 indicates a frequency of 59.9Hz.

*Table 3.19: Old 2033A Register List (Inverter Voltages)*

Register	Measurement	Notes
4x0001	UPS Device Type	Integer Value 7 = Old 2033A
4x0002	Inverter Output Voltage A-N	x0.1 VAC
4x0003	Inverter Output Voltage B-N	x0.1 VAC
4x0004	Inverter Output Voltage C-N	x0.1 VAC
4x0005	Inverter Output Voltage A-B	x0.1 VAC
4x0006	Inverter Output Voltage B-C	x0.1 VAC
4x0007	Inverter Output Voltage C-A	x0.1 VAC

*Table 3.20: Old 2033A Register List (Bypass Input Voltages)*

Register	Measurement	Notes
4x0008	Bypass Input Voltage Phase A-N	x0.1 VAC
4x0009	Bypass Input Voltage Phase B-N	x0.1 VAC
4x0010	Bypass Input Voltage Phase C-N	x0.1 VAC
4x0011	Bypass Input Voltage Phase A-B	x0.1 VAC
4x0012	Bypass Input Voltage Phase B-C	x0.1 VAC
4x0013	Bypass Input Voltage Phase C-A	x0.1 VAC

*Table 3.21: Old 2033A Register List (Output Currents)*

Register	Measurement	Notes
4x0014	Output Current Phase A	x.1 A
4x0015	Output Current Phase B	x.1 A
4x0016	Output Current Phase C	x.1 A
4x0017	Output Current N	x.1 A
4x0018	Output Peak Current Phase A	x.1 A
4x0019	Output Peak Current Phase B	x.1 A
4x0020	Output Peak Current Phase C	x.1 A
4x0021	Output Peak Current N	x.1 A

*Table 3.22: Old 2033A Register List (Battery)*

Register	Measurement	Notes
4x0022	Battery Voltage	x0.1 VDC
4x0023	Battery Current	x0.1 A

*Table 3.23: Old 2033A Register List (Other)*

Register	Measurement	Notes
4x0024	Input Voltage	?
4x0025	Bypass Input Frequency	x0.1 Hz
4x0026	Inverter Output Frequency	x0.1 Hz
4x0027	Battery Flag	1 = discharge current 2 = charge current
4x0028	Input Port Latch Data 0	
4x0029	Input Port Latch Data 1	
4x0030	Input Port Latch Data 2	
4x0031	Input Port Latch Data 3	
4x0032	Input Port Latch Data 4	
4x0033	Input Port Latch Data 5	



Register	Measurement	Notes
4x0034	Input Port Latch Data 6	
4x0035	Input Port Latch Data 7	
4x0036	Input Port Latch Data 8	
4x0037	Input Port Latch Data 9	
4x0038	Fault Flag	
4x0039	External Output Status 1	
4x0040	External Output Status 2	
4x0041	External Output Status 3	

*Table 3.24: Old 2033A Register List (Active Fault Codes)*

Register	Measurement	Notes
4x0024	Input Voltage	?
4x0025	Bypass Input Frequency	x0.1 Hz
4x0026	Inverter Output Frequency	x0.1 Hz
4x0027	Battery Flag	1 = discharge current 2 = charge current
4x0028	Input Port Latch Data 0	
4x0029	Input Port Latch Data 1	
4x0030	Input Port Latch Data 2	
4x0031	Input Port Latch Data 3	
4x0032	Input Port Latch Data 4	
4x0033	Input Port Latch Data 5	
4x0034	Input Port Latch Data 6	
4x0035	Input Port Latch Data 7	
4x0036	Input Port Latch Data 8	
4x0037	Input Port Latch Data 9	
4x0038	Fault Flag	
4x0039	External Output Status 1	
4x0040	External Output Status 2	
4x0041	External Output Status 3	

---

## 4 LonWorks

The Niobrara MLWF-001 LonWorks adapter may be used with the MUCM Mitsubishi application to present the UPS data onto LonWorks. The MLWF supports the 78-kbaud free-topology LonWorks network. The LonWorks interface is limited to 63 network variables so three different Neuron® 'C' programs are provided to support the three different UPS register maps: 2033A, 2033C, and 2033D. The Neuron program loaded into the MLWF must match the UPS selected in the MUCM setup.

The MLWF may be ordered with the application preloaded for the specific UPS. Order Part Number:

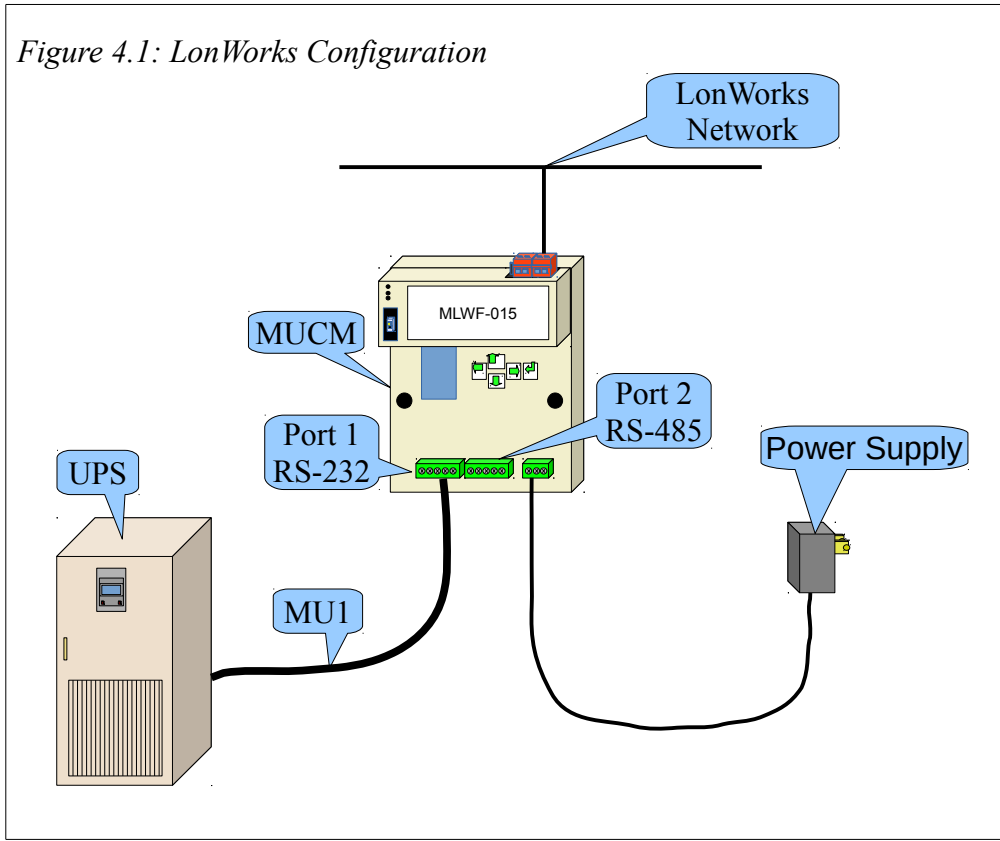
- MLWF-013 for 2033A and 9700 UPS
- MLWF-014 for 2033C UPS
- MLWF-015 for 2033D, 7011, and 9800AD UPS

The MUCM may also be ordered with the MLWF attached and both preloaded with the correct applications. Order Part Number:

- MCP-104-013 is the MCP-104 kit with MUCM preloaded with Mitsubishi application and MLWF-013 installed
- MCP-104-014 is the MCP-104 kit with MUCM preloaded with Mitsubishi application and MLWF-014 installed
- MCP-104-015 is the MCP-104 kit with MUCM preloaded with Mitsubishi application and MLWF-015 installed

See Appendix A for other ordering options.

Figure 4.1: LonWorks Configuration



If the MUCM reports a different UPS type than the MLWF is programmed for then the MLWF will flash its green Active light. If the UPS matches then the Active light is on solid. If the MLWF is not installed on an MUCM then both the green Active and yellow Network lights flash continuously.

## 2033A Neuron Program

Table 4.1 shows the LonWorks files to be used when interfacing the Mitsubishi 2033A and 9700 UPSs.

*Table 4.1: 2033A (and 9700)Files*

File	Description
2033A.APB	Application Image (used by LonMaker)
2033A.NC	Neuron C source file
2033A.NXE	Executable interface file (used by other LonWorks management tools)
2033A.XIF	External Interface File (used by LonMaker)

*Table 4.2: 2033A, 9700 LonWorks Network Variable List (Battery)*

Network Variable	Network Variable Type	Modbus Register	Measurement	Notes
NvoPercBattLeft	SNVT_switch	4x0007	% Battery Charge Left	x0.5 %
NvoBattVoltage	SNVT_volt	4x0008	Battery Voltage	x0.1 VDC
NvoBattCurrent	SNVT_amp	4x0009	Battery Current	x0.1 A
NvoDischargeHr	SNVT_time_hour	4x0011	Discharge Time	Hours
NvoDischargeMin	SNVT_time_min	4x0012	Discharge Time	Minutes
NvoDischargeSec	SNVT_time_sec	4x0013	Discharge Time	x0.1 Seconds

*Table 4.3: 2033A, 9700 LonWorks Network Variable List (Input)*

Network Variable	Network Variable Type	Modbus Register	Measurement	Notes
NvoInpLineBads	unsigned long	4x0014	Input Line Bads	Count
NvoInpFreq	SNVT_freq_hz	4x0015	Input Frequency	x0.1 Hz
NvoInpVoltageAB	SNVT_volt	4x0019	Input Voltage Phase A-B	x0.1 VAC
NvoInpVoltageBC	SNVT_volt	4x0020	Input Voltage Phase B-C	x0.1 VAC
NvoInpVoltageCA	SNVT_volt	4x0021	Input Voltage Phase C-A	x0.1 VAC
NvoInpVoltageAN	SNVT_volt	4x0022	Input Voltage Phase A-N	x0.1 VAC
NvoInpVoltageBN	SNVT_volt	4x0023	Input Voltage Phase B-N	x0.1 VAC
NvoInpVoltageCN	SNVT_volt	4x0024	Input Voltage Phase C-N	x0.1 VAC
NvoInpCurrentA	SNVT_amp	4x0025	Input Current Phase A	x0.1 A
NvoInpCurrentB	SNVT_amp	4x0026	Input Current Phase B	x0.1 A
NvoInpCurrentC	SNVT_amp	4x0027	Input Current Phase C	x0.1 A0

Table 4.4: 2033A, 9700 LonWorks Network Variable List (Output)

Network Variable	Network Variable Type	Modbus Register	Measurement	Notes
NvoOutpVoltageAB	SNVT_volt	4x0033	Output Voltage Phase A-B	x0.1 VAC
NvoOutpVoltageBC	SNVT_volt	4x0034	Output Voltage Phase B-C	x0.1 VAC
NvoOutpVoltageCA	SNVT_volt	4x0035	Output Voltage Phase C-A	x0.1 VAC
NvoOutpVoltageAN	SNVT_volt	4x0036	Output Voltage Phase A-N	x0.1 VAC
NvoOutpVoltageBN	SNVT_volt	4x0037	Output Voltage Phase B-N	x0.1 VAC
NvoOutpVoltageCN	SNVT_volt	4x0038	Output Voltage Phase C-N	x0.1 VAC
NvoOutpCurrentA	SNVT_amp	4x0039	Output Current Phase A	x0.1 A
NvoOutpCurrentB	SNVT_amp	4x0040	Output Current Phase B	x0.1 A
NvoOutpCurrentC	SNVT_amp	4x0041	Output Current Phase C	x0.1 A
NvoOutpPkCurrenAt	SNVT_amp	4x0042	Output Peak Current Phase A	x0.1 A
NvoOutpPkCurrentB	SNVT_amp	4x0043	Output Peak Current Phase B	x0.1 A
NvoOutpPkCurrentC	SNVT_amp	4x0044	Output Peak Current Phase C	x0.1 A
NvoOutpFreq	SNVT_freq_hz	4x0051	Output Frequency	x0.1 Hz
NvoOutpPower	SNVT_power	4x0052	Output Power	0.1 W
NvoOutpPowerFact	unsigned long	4x0053	Output Power Factor	x0.01%
NvoOutpCurrentN	SNVT_amp	4x0092	Output Current Phase N	x0.1 A

Table 4.5: 2033A, 9700 LonWorks Network Variable List (Bypass)

Network Variable	Network Variable Type	Modbus Register	Measurement	Notes
NvoBypVoltageAB	SNVT_volt	4x0054	Bypass Voltage Phase A-B	x0.1 VAC
NvoBypVoltageBC	SNVT_volt	4x0055	Bypass Voltage Phase B-C	x0.1 VAC
NvoBypVoltageCA	SNVT_volt	4x0056	Bypass Voltage Phase C-A	x0.1 VAC
NvoBypVoltageAN	SNVT_volt	4x0057	Bypass Voltage Phase A-N	x0.1 VAC
NvoBypVoltageBN	SNVT_volt	4x0058	Bypass Voltage Phase B-N	x0.1 VAC
NvoBypVoltageCN	SNVT_volt	4x0059	Bypass Voltage Phase C-n	x0.1 VAC
NvoBypFreq	SNVT_freq_hz	4x0066	Bypass Frequency	x0.1 Hz

Table 4.6: 2033A, 9700 LonWorks Network Variable List (Alarms)

Network Variable	Network Variable Type	Modbus Register	Bit	Code	Description
NvoFault[0]	Unsigned long	4x0068 Fault 1 (Bits 0-15)	1	UF007	Converter Input Current Sensor Abnormal
			2	UF105	DC Voltage Sensor Circuit Abnormal
			5	UF102	DC Undervoltage
			6	UF103	DC Overvoltage

Network Variable	Network Variable Type	Modbus Register	Bit	Code	Description
			11	UF216	Inverter Output Current Sensor Abnormal
			12	UF201	Inverter Output Overvoltage +15%
			13	UF202	Inverter Output Undervoltage -15%
NvoFault[1]	unsigned long	4x0069 Fault 1 (Bits 16-31)	0	UF306	UPS Control Power Circuit Error
			3	UF301	UPS Control Microprocessor Circuit Error
			5	UF305	UPS Control Circuit Error
			10	UF203	Inverter Output Overcurrent
			12	UF302	UPS Control Microprocessor Circuit Error
			13	UF303	UPS Control Microprocessor Circuit Error
			15	UF304	UPS Control Microprocessor Circuit Error
			NvoFault[2]	unsigned long	4x0070 Fault 2 (Bits 0-15)
NvoFault[3]	unsigned long	4x0071 Fault 2 (Bits 16-31)	None	None	Reserved, No alarms
NvoFault[4]	unsigned long	4x0072 Fault 3 (Bits 0-15)	0	UF003	Converter Abnormal
			1	UF212	Fan Power Source Abnormal
			2	UF107	CB2 Abnormal
			3	UF214	Cooling Fan Thermal Relay Abnormal
			5	UF213	Inverter or Converter Overtemperature
			9	UF307	UPS Control Circuit Error
			11	UF209	52C Abnormal (Not Closed)
			12	UF210	52C Abnormal (Not Open)
			13	UF106	DC Capacitor Abnormal
			15	UF255	52C Abnormal
NvoFault[5]	unsigned long	4x0073 Fault 3 (Bits 16-31)	3	UF309	Inverter Output Voltage Sensed before 52C Closed
			4	UF401	52S Abnormal (Not Closed or Closed without command)
			5	UF402	52S Abnormal (Not Opened or Open without command)
			6	UF215	Frequent Overload
NvoFault[6]	unsigned long	4x0074 Fault 4 (Bits 0-15)	0	UF053	Input Contactor CB1 not Open under correct sequence
			1	UF052	Input Circuit Breaker CB1 Tripped
			2	UF257	52C Abnormal, did NOT Open after manual transfer to bypass.
			3	UF451	52S Abnormal NOT closed, or closed with no manual transfer command.
			4	UF153	CB2 DC Circuit Breaker Tripped
			5	UF154	CB2 Abnormal

Network Variable	Network Variable Type	Modbus Register	Bit	Code	Description
			9	UF158	Battery Liquid Level Low
			10	UF157	Battery Overtemperature
			11	UF156	CB2 Tripped (after prolonged battery overtemperature 2Hr)
			13	UF256	Output Voltage Abnormal outside +/-5%
			15	UF352	Control Power Supply Abnormal
NvoFault[7]	unsigned long	4x0075 Fault 4 (Bits 16-31)	0	UF159	DC Ground Fault
			2	UF160	DC Circuit Sensor Abnormal
			3	UF351	DC Control Fuse Blown
			4	UF151	DC Voltage Abnormal, DC Buss does not return to Float after power restored (24Hr)
			5	UF152	DC Voltage Abnormal, DC Buss does not return to Equalize after power restored (24Hr)
			9	UF162	DC Circuit Abnormal
			11	UF356	UPS Control Circuit Error
			12	UF357	"Inverter Start" Switch Abnormal
			13	UF358	"Inverter Stop" Switch Abnormal
			14	UF359	"Inverter Operation" Switch Abnormal
			15	UF360	"Bypass Operation" Switch Abnormal
NvoFault[8]	unsigned long	4x0076 Fault 5 (Bits 0-15)	0	UF255	52C Abnormal, Opened during Inverter Load Supply
			2	UF355	UPS Control Circuit Error
NvoFault[9]	unsigned long	4x0077 Fault 5 (Bits 16-31)	None	None	Reserved, No alarms
NvoFault[10]	unsigned long	4x0078 Fault 6 (Bits 0-15)	1	UA802	AC Input Frequency Out of Range
NvoFault[11]	unsigned long	4x0079 Fault 6 (Bits 16-31)	None	None	Reserved, No alarms
NvoFault[12]	unsigned long	4x0080 Fault 7 (Bits 0-15)	0	UF056	Converter Input Current Overload
			1	UF058	Cooling Fan Abnormal (Converter Circuit)
			2	UF057	Converter Overtemperature
			3	UF362	UPS Control Circuit Error
			4	UF161	CB2 Tripped (DC Voltage Abnormal) DC Buss does not return to Float after power restored (48Hr)
			5	UF254	88C Abnormal Fan AC Source Abnormal during Inverter Operation
			6	UF059	Converter Abnormal, Preliminary Charge Impossible

Network Variable	Network Variable Type	Modbus Register	Bit	Code	Description
			7	UF060	Converter Abnormal
			8	UF363	Voltage Adjust Error
			9	UF258	Frequent Overload
NvoFault[13]	unsigned long	4x0081 Fault 7 (Bits 16-31)	8	UF806	Inverter Overload > 100%
			9	UF807	Inverter Overload > 110%
			10	UF808	Inverter Overload > 125%
			11	UF809	Inverter Overload > 150%
			12	UF810	Inverter Overload, Momentary Overcurrent while load powered by inverter
			13	UF836	Converter Overload
NvoFault[14]	unsigned long	4x0082 Fault 8 (Bits 0-15)	0	UA823	CB1 OFF, AC Input Contactor OPEN
			1	UA824	CB2 OFF, DC Contactor OPEN
			2	UA826	CB101 OFF, Control Breaker Opened During Inverter Load Supply.
			5	UA819	Remote Start Button Abnormal
			6	UA820	Remote Stop button Abnormal
			7	UA812	Bypass Voltage Out of Range +20%
			8	UA817	Emergency Stop Activated
			9	UA827	52C Not Permitted, Transfer Permitted switch open
			10	UA830	AC Input Undervoltage
			11	None	Manual Bypass Switch ON
			12	UA803	AC Input Phase Rotation Error
			13	UA805	Ambient Temperature Abnormal HIGH
			14	UA804	Battery DC Precharge Circuit Abnormal
			15	UA801	AC Input Voltage Out of Range Fell below 18% threshold.
			NvoFault[15]	unsigned long	4x0083 Fault 8 (Bits 16-31)
1	None	Transfer Failure (Load Stop)			
2	UA813	Bypass Phase Rotation Error			
3	UA814	Bypass Frequency Out of Range			
4	UA816	Extended Bypass Operation (10 minutes)			
5	UA831	Emergency Bypass Switch ON			
6	UA822	Generator Operation (Transfer to Bypass not permitted)			
8	UA832	Interrupted Transfer to Bypass			
9	UA821	UPS Stopped (Transfer Inhibited, Bypass Voltage out of range)			
10	UA835	UPS Stopped (Transfer Inhibited, Inverter Asynchronous)			
11	UA804	Battery Abnormal			



Table 4.7: 2033A, 9700 LonWorks Network Variable List (Status)

Network Variable	Network Variable Type	Modbus Register	Bit	Description
NvoStatus1Lo	unsigned long	4x0084 Status 1 (Bits 0-15)	0	Inverter is operating and powering the load
			1	Ex. Alarm, Minor Fault
			2	Inverter Running
			3	Inverter S/S, Inverter is Started from Local or Remote
			4	Battery Operation 1, 3 minute alarm time delay after battery backup
			5	Battery Low Voltage, near depletion due to prolonged AC Fail
			6	Overload, UPS Output Capacity Exceeded
			7	Overload, (Level Reached)
			8	Enable to Remote Operation
			9	Remote Operation
			10	Battery Depletion, Shutdown Imminent
			11	Battery Abnormal, Overtemperature or Low Liquid Level
			12	Converter Operation, 1=Running
			13	Battery Operation 2, UPS in Battery Backup Mode
			14	CB1 1=Closed
15	CB2 1=Closed			
NvoStatus1Hi	unsigned long	4x0085 Status 1 (Bits 16-31)	0	Converter is operating and supplying Inverter
			1	Battery Operation 3, No alarm time delay after battery backup initiated
			2	52C 1=Closed
			3	AC Input Abnormal, Voltage or Frequency out of range
			4	Equalize Charge, UPS in Equalize Mode
			5	Output Overload, (Inverter Stop)
			6	Test Mode
			7	Output Switch Abnormal, 52S or 52C Abnormal
			8	Battery Charge
NvoStatus2Lo	unsigned long	4x0086 Status 2 (Bits 0-15)	0	CB1 Alarm
			1	CB2 Alarm
			2	52C Alarm
NvoStatus2Hi	unsigned long	4x0087 Status 2 (Bits 16-31)	None	Reserved
NvoStatus3Lo	unsigned long	4x0088 Status 3	0	Synchronism, Inverter is synchronized to external source

Network Variable	Network Variable Type	Modbus Register	Bit	Description
		(Bits 0-15)	1	Asynchronism, Inverter is in the free running mode
			2	Voltage Equalize Answer, DC Voltage reached equalizing voltage level
			5	52S 1=Closed
			6	CB3 1=Closed
			7	Bypass Operation, Load powered via static Bypass Line
			8	Bypass Input Abnormal, Voltage or Frequency Out of Range
			10	Bypass Abnormal
			12	Synchronism 2
			13	Load Supply, Load powered by UPS (Inverter or Bypass)
			14	Generator Operation, 1=UPS on Generator
NvoStatus4Lo	unsigned long	4x0090 EX Status (Bits 0-15)	0	Direction of Battery Current (1=Discharge, 0=Charging)
			1	Battery Floating
			2	Input Power Failure Detection
			3	Input Power Failure

## 2033C Neuron Program

Table 4.8 shows the LonWorks files to be used when interfacing the Mitsubishi 2033C UPS.

Table 4.8: 2033C Files

File	Description
2033C.APB	Application Image (used by LonMaker)
2033C.NC	Neuron C source file
2033C.NXE	Executable interface file (used by other LonWorks management tools)
2033C.XIF	External Interface File (used by LonMaker)

Table 4.9: 2033C LonWorks Network Variable List (Battery)

Network Variable	Network Variable Type	Modbus Register	Measurement	Notes
NvoBattCondition	unsigned long	4x0002	Battery Condition	Integer Value 0=Good 1=Weak 2=Replace

Network Variable	Network Variable Type	Modbus Register	Measurement	Notes
NvoBattStatus	unsigned long	4x0003	Battery Status	Integer Value 0=OK 1=Low 2=Depleted
NvoBattCharge	unsigned long	4x0004	Battery Charge	Integer Value 0=Floating 1=Charging 2=Resting 3=Discharging
NvoSecondsOnBatt	SNVT_time_sec	4x0005	Seconds on Battery	x0.1 Seconds
NvoMinutesRemain	SNVT_time_min	4x0006	Estimated Minutes Remaining	Minutes
NvoPercBattLeft	SNVT_switch	4x0007	% Battery Charge Left	x0.5 %

Table 4.10: 2033C LonWorks Network Variable List (Input)

Network Variable	Network Variable Type	Modbus Register	Measurement	Notes
NvoInpLineBads	unsigned long	4x0014	Input Line Bads	Count
NvoInpFreq	SNVT_freq_hz	4x0016	Input Frequency	x0.1 Hz
NvoInpVoltage	SNVT_volt	4x0022	Input Voltage	x0.1 VAC
NvoInpCurrent	SNVT_amp	4x0025	Input Current	x0.1 A
NvoInpPower	SNVT_power	4x0029	Input Power	x0.1 W

Table 4.11: 2033C LonWorks Network Variable List (Output)

Network Variable	Network Variable Type	Modbus Register	Measurement	Notes
NvoOutpSource	unsigned long	4x0032	Output Source	Integer Value 0=Normal 1=On Battery 2=On Bypass 3=Reducing 4=Boosting 5=Other
NvoOutpVoltage	SNVT_volt	4x0036	Output Voltage	x0.1 VAC
NvoOutpCurrent	SNVT_amp	4x0039	Output Current	x0.1 A
NvoOutpPower	SNVT_power	4x0045	Output Power	0.1 W
NvoOutpPercLoad	SNVT_switch	4x0048	Output % Load	x0.5 %
NvoOutpFreq	SNVT_freq_hz	4x0051	Output Frequency	x0.1 Hz

Table 4.12: 2033C LonWorks Network Variable List (Alarms)

Network Variable	Network Variable Type	Modbus Register	Bit	Description
NvoAlarms	unsigned long	4x0067	0	Temperature Alarm
			1	Input Bad Alarm
			2	Output Bad Alarm
			3	Overload Alarm
			4	Bypass Bad Alarm
			5	Output Off Alarm
			6	UPS Shutdown Alarm
			7	Charger Failure Alarm
			8	System Off Alarm
			9	Fan Failure Alarm
			10	Fuse Failure Alarm
			11	General Fault Alarm
			12	Awaiting Power Alarm
			13	Shutdown Pending Alarm
			14	Shutdown Imminent Alarm
15	Reserved			

**Example:**  
 Decimal value = 96  
 Binary value = 0000 0000 0110 0000  
 Alarm Bit 5 and 6 are ON all others are OFF

### 2033D Neuron Program

Table 4.13 shows the LonWorks files to be used when interfacing the Mitsubishi 2033D, 7011A, 9800AD, and 9900 UPS. As of September 3, 2009, the files use Standard Network Variable Types, rather than the unsigned longs that were previously used.

Table 4.13: 2033D, 7011A, 9800AD, 9900 Neuron Files

File	Description
2033D.APB	Application Image (used by LonMaker)
2033D.NC	Neuron C source file
2033D.NXE	Executable interface file (used by other LonWorks management tools)
2033D.XIF	External Interface File (used by LonMaker)

*Table 4.14: 2033D, 7011A, 9800AD, 9900 LonWorks Network Variable List (Battery)*

Network Variable	Network Variable Type	Modbus Register	Measurement	Notes
NvoBattStatus	unsigned long	4x0003	Battery Status	Integer Value 0=OK 1=Low 2=Depleted
NvoBattCharge	unsigned long	4x0004	Battery Charge	Integer Value 0=Floating 1=Charging 2=Resting 3=Discharging
NvoSecondsOnBatt	SNVT_time_sec	4x0005	Seconds on Battery	x0.1 Seconds
NvoPercBattLeft	SNVT_switch	4x0007	% Battery Charge Left	x0.5 %
NvoBattVoltage	SNVT_volt	4x0008	Battery Voltage	x0.1 VDC

*Table 4.15: 2033D, 7011A, 9800AD, 9900 LonWorks Network Variable List (Input)*

Network Variable	Network Variable Type	Modbus Register	Measurement	Notes
NvoInpLineBads	unsigned long	4x0014	Input Line Bads	Count
NvoInpFreq	SNVT_freq_hz	4x0016	Input Frequency	x0.1 Hz
NvoInpVoltage	SNVT_volt	4x0022	Input Voltage	x0.1 VAC

*Table 4.16: 2033D, 7011A, 9800AD, 9900 LonWorks Network Variable List (Output)*

Network Variable	Network Variable Type	Modbus Register	Measurement	Notes
NvoOutpSource	unsigned long	4x0032	Output Source	Integer Value 0=Normal 1=On Battery 2=On Bypass 3=Reducing 4=Boosting 5=Other
NvoOutpVoltageAB	SNVT_volt	4x0036	Output Voltage Phase A-B	x0.1 VAC
NvoOutpVoltageBC	SNVT_volt	4x0037	Output Voltage Phase B-C	x0.1 VAC
NvoOutpVoltageCA	SNVT_volt	4x0038	Output Voltage Phase C-A	x0.1 VAC
NvoOutpCurrent	SNVT_amp	4x0039	Output Current Phase A	x0.1 A
NvoOutpCurrent	SNVT_amp	4x0040	Output Current Phase B	x0.1 A
NvoOutpCurrent	SNVT_amp	4x0041	Output Current Phase C	x0.1 A
NvoOutpPower	SNVT_power	4x0045	Output Power	0.1 W
NvoOutpPercLoad	SNVT_switch	4x0048	Output % Load Phase A	x0.5 %

Network Variable	Network Variable Type	Modbus Register	Measurement	Notes
NvoOutPercLoad	SNVT_switch	4x0049	Output % Load Phase B	x0.5 %
NvoOutPercLoad	SNVT_switch	4x0050	Output % Load Phase C	x0.5 %
NvoOutFreq	SNVT_freq_hz	4x0051	Output Frequency	x0.1 Hz

*Table 4.17: 2033D, 7011A, 9800AD, 9900 LonWorks Network Variable List (Bypass)*

Network Variable	Network Variable Type	Modbus Register	Measurement	Notes
NvoBypVoltageAC	SNVT_volt	4x0057	Bypass Voltage Phase AB	x0.1 VAC
NvoBypVoltageBC	SNVT_volt	4x0058	Bypass Voltage Phase BC	x0.1 VAC
NvoBypVoltageCA	SNVT_volt	4x0059	Bypass Voltage Phase CA	x0.1 VAC
NvoBypCurrentA	SNVT_amp	4x0060	Bypass Current Phase A	x0.1 A
NvoBypCurrentB	SNVT_amp	4x0061	Bypass Current Phase B	x0.1 A
NvoBypCurrentC	SNVT_amp	4x0062	Bypass Current Phase C	x0.1 A
NvoBypPower	SNVT_power	4x0063	Bypass Power	x0.1 W
NvoBypFreq	SNVT_freq_hz	4x0066	Bypass Frequency	x0.1 Hz

*Table 4.18: 2033D, 7011A, 9800AD, 9900 LonWorks Network Variable List (Alarms)*

Network Variable	Network Variable Type	Modbus Register	Bit	Description
NvoAlarms	unsigned long	4x0067	0	Temperature Alarm
			1	Input Bad Alarm
			2	Output Bad Alarm
			3	Overload Alarm
			4	Bypass Bad Alarm
			5	Output Off Alarm
			6	UPS Shutdown Alarm
			7	Charger Failure Alarm
			8	System Off Alarm
			9	Fan Failure Alarm
			10	Fuse Failure Alarm
			11	General Fault Alarm
			12	Awaiting Power Alarm
			13	Shutdown Pending Alarm
			14	Shutdown Imminent Alarm
15	Reserved			



---

## 5 Examples

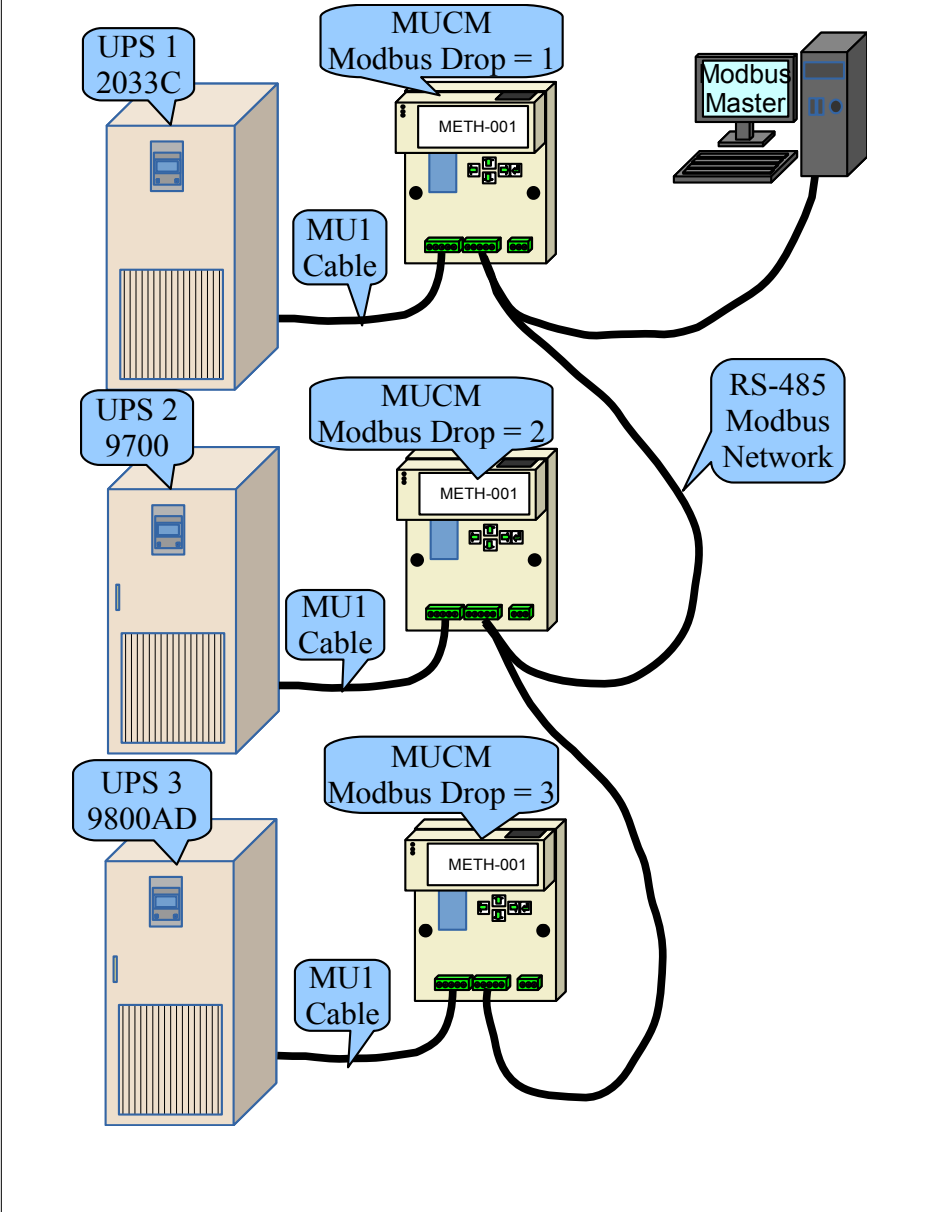
Table 5.1 shows system with three UPSs to be connected to a Modbus master. UPS 1 is a 2033C, UPS 2 is a 9700, and UPS 3 is a 9800AD. Each UPS has its own MUCM connected via an MU1 RS-232 cable. The Modbus RTU Master has an RS-485 port and is configured for 19200 baud, 8 data bits, 1 stop bit and NONE parity. Each MUCM is configured as shown in Table 5.1.

*Table 5.1: Example 1 Settings*

Parameter	MUCM 1		MUCM 2		MUCM 3	
	Port 1	Port 2	Port 1	Port 2	Port 1	Port 2
Protocol Mode	2033C UPS	Modbus RTU	9700 UPS	Modbus RTU	9800AD UPS	Modbus RTU
Baud Rate	N/A	19200	N/A	19200	N/A	19200
Parity	N/A	NONE	N/A	NONE	N/A	NONE
Data Bits	N/A	8	N/A	8	N/A	8
Stop Bits	N/A	1	N/A	1	N/A	1
Slave Address	N/A	1	N/A	2	N/A	3

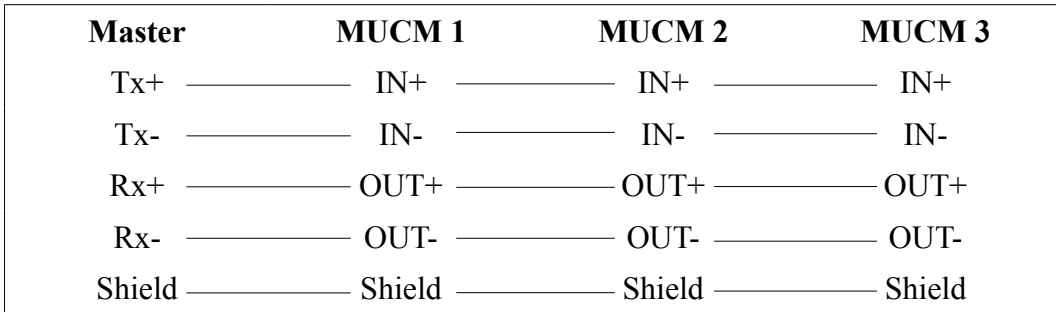


Figure 5.1: Example 1 Configuration



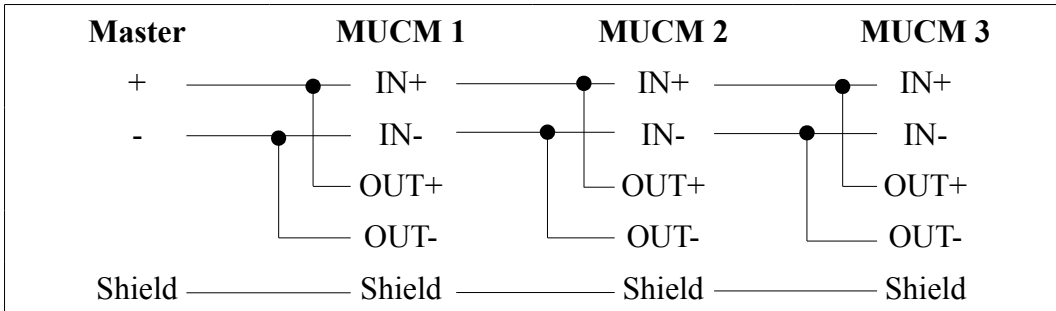
Port 2 of the MUCM is RS-485 so a simple 4-wire cable is required to connect to most Modbus equipment. A twisted pair cable such as Belden 8723 should be used with one pair on the TX and the other pair on the RX circuit.

*Figure 5.2: 4-wire RS-485 Example*



If the Modbus Master has a 2-wire RS-485 port then use a single twisted pair cable and jumper the IN+ to OUT+ at each MUCM for the (+) connection as well as jumper the IN- to OUT- for the (-) connection.

*Figure 5.3: 2-wire RS-485 Example*



---

## 6 Testing and Troubleshooting

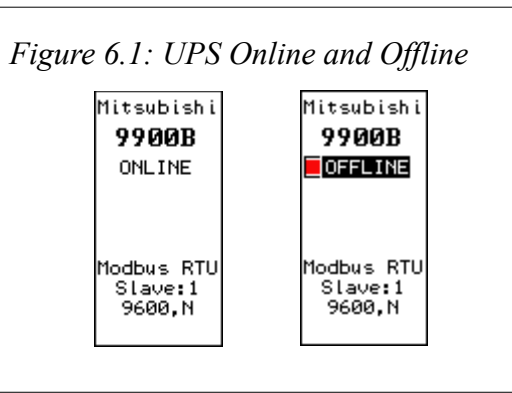
### ***MUCM Lights***

The MUCM has several lights to give indication of activity of the application and serial ports.

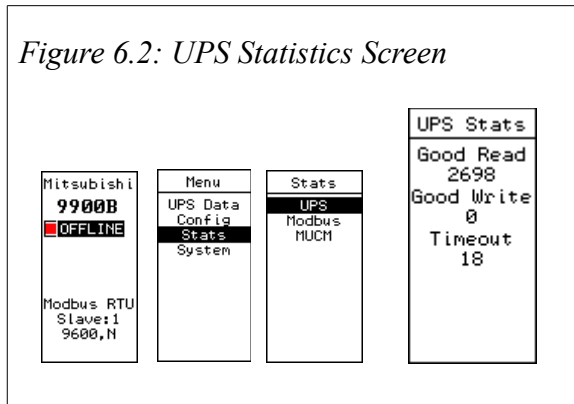
- The **Pwr** light is green and indicates that the MUCM is powered.
- The yellow **Tx1** light indicates that the MUCM RS-232 port is transmitting data. This light should normally be quickly flashing as the MUCM polls the UPS.
- The yellow **Rx1** light indicates that the MUCM RS-232 port is receiving data. This light should normally be quickly flashing as the MUCM polls the UPS.
- The yellow **Tx2** light indicates that the MUCM RS-485 port is transmitting data. This light should normally be occasionally flashing as the Modbus Master polls the MUCM.
- The yellow **Rx2** light indicates that the MUCM RS-485 port is receiving data. This light should normally be occasionally flashing as the Modbus Master polls the MUCM. This light may flash without the Tx2 light as the Modbus Master polls other devices on the RS-485 network.
- **Light 1** is a red light placed behind the LCD screen and is controlled by the application. If light 1 is on a warning or error message will appear on the LCD.
- **Light 2** is a red light placed behind the LCD screen and is controlled by the application. If light 1 is on a warning or error message will appear on the LCD.

### ***Testing the UPS Connection***

When the MUCM port 1 is connected to the UPS using the MU1 or MU17 cable and the correct UPS type from the configuration menu is selected. The MUCM will begin polling the UPS. Looking at the MUCM you should see the Tx1 light quickly flash closely followed by the Rx1 light quickly flash. If the UPS is communicating with the MUCM the LCD screen will display ONLINE. If the UPS is not responding the Rx1 light will not blink and the LCD screen will display OFFLINE.



If the UPS is OFFLINE the MUCM will stop responding to Modbus queries from the master and the Time Outs will begin counting up on the UPS statistics screen.



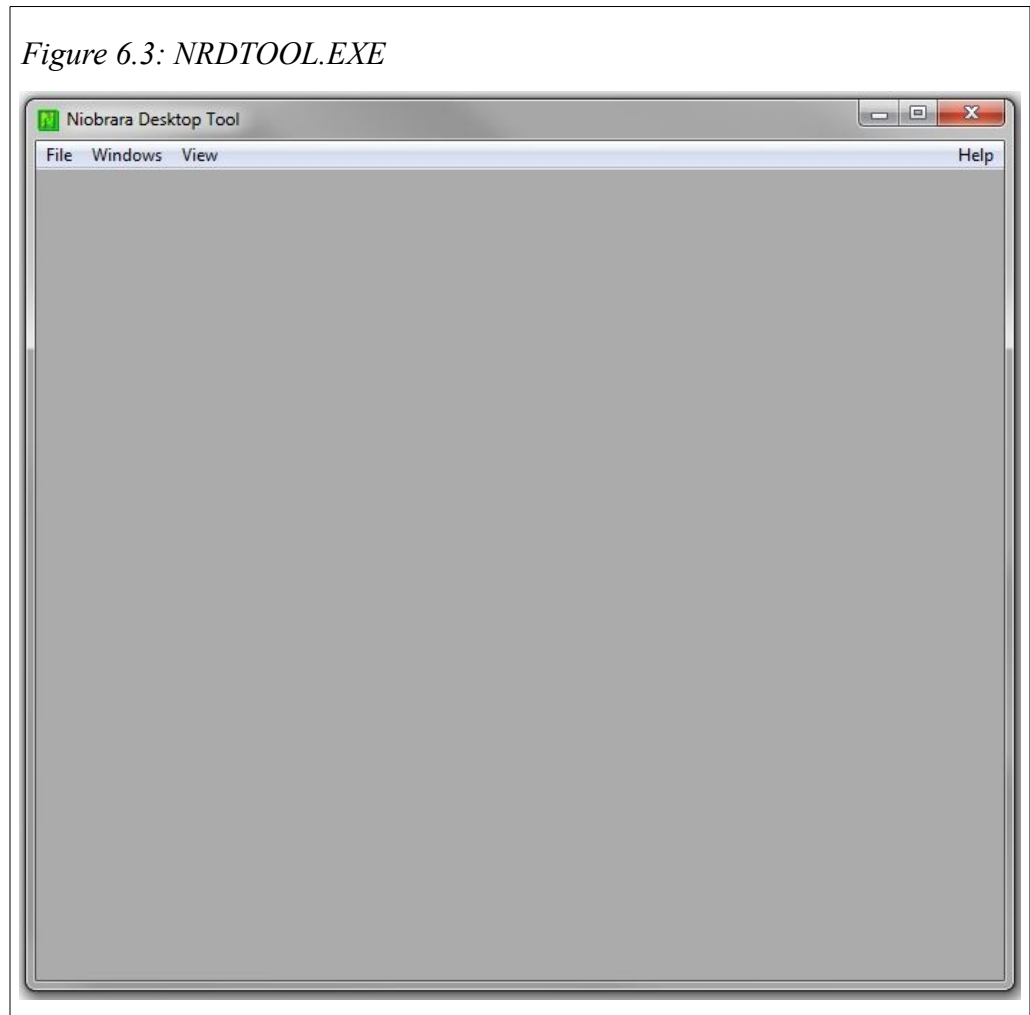
## **Testing the Modbus Connection**

The program NRDTOOL.EXE may be used to quickly test the Modbus settings on the MUCM. NRDTOOL.EXE is a register editor contained in MUCM\_SETUP.EXE.

1. Download and install MUCM\_SETUP.EXE from [www.nibrara.com](http://www.nibrara.com). On the Web site go to Products, Modicon Products, Momentum, MUCM, Software. This will download the MUCM\_SETUP.EXE.
2. Connect the Niobrara SC912 cable or other RS-232 <> RS-422 converter to the MUCM port 2 and the serial port of the PC. The SC912 external power supply must be used.

3. Start NRDTOOL.EXE. On most Windows systems do a Start, All Programs, Niobrara, NrdTool. See Figure 6.3.

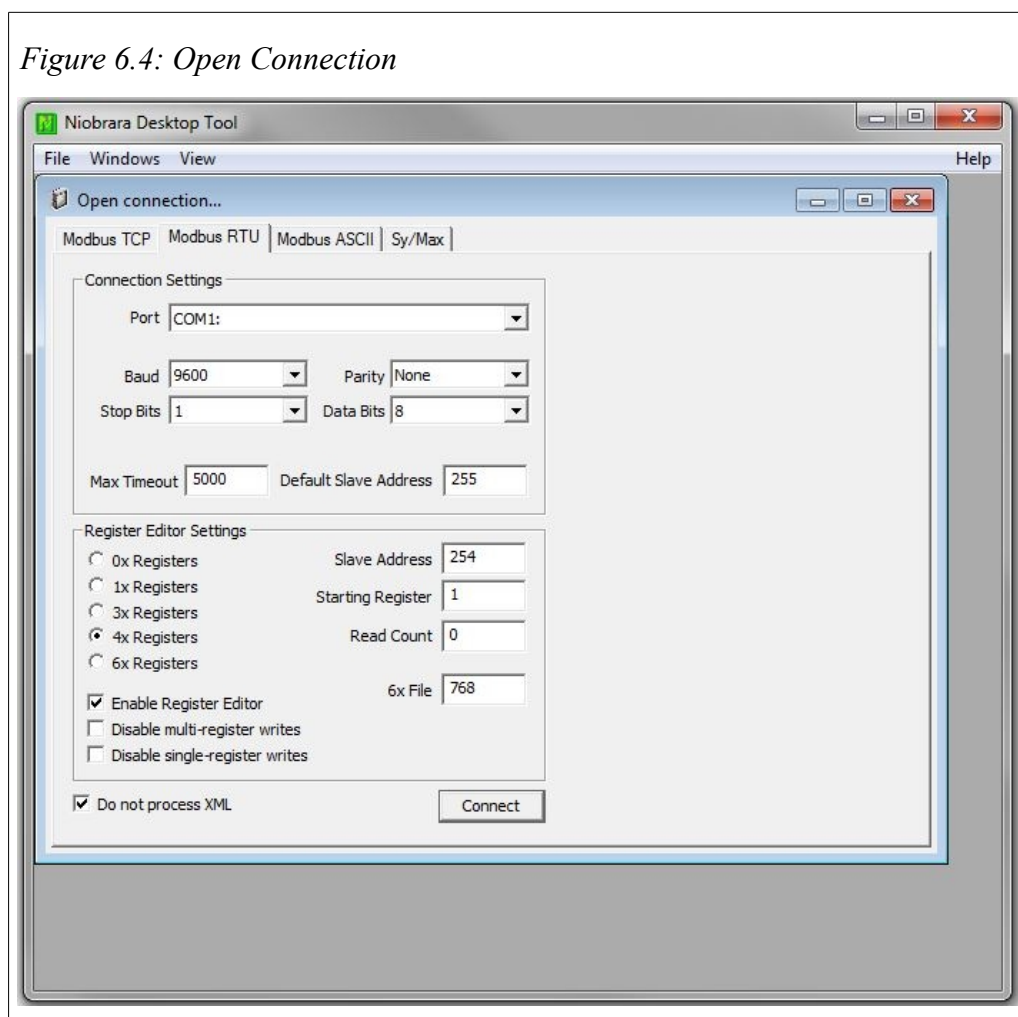
*Figure 6.3: NRDTOOL.EXE*



4. File, Open Connection
5. Select the Modbus RTU tab
6. Check that the Connection settings match the MUCM port 2 settings. The Default Slave Address leave at 255. See Figure 6.4

7. Under Register Editor Settings check that 4x registers is selected, set slave address to 254, Starting Register to 1, Read Count to 0, Enable Register Editor is checked, and Do Not Process XML is checked. See Figure 6.4

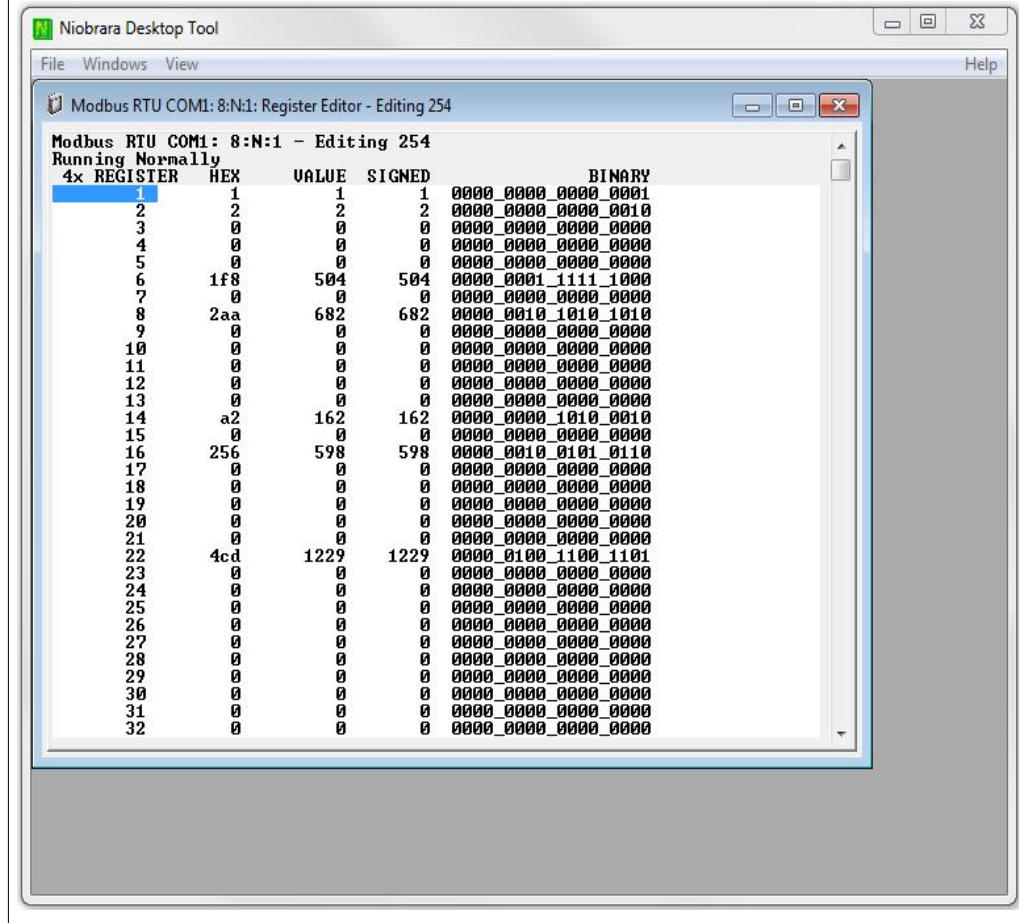
Figure 6.4: Open Connection



- Click Connect. Slave address 254 is a special drop number that the MUCM will respond to whether it is talking to the UPS or not.

A screen like Figure 6.5 should appear. The left column is the Holding Register number, the data is shown in the HEX, UNSIGNED, SIGNED, and BINARY columns. The arrow keys and Page UP/Down may be used to move around. Values may be entered directly and the change occurs when the Enter key is pressed.

Figure 6.5: Connected to Slave Address 254



When finished verifying that the communication is good, Close NRDTOOL.EXE.







To verify that the UPS data is present, substitute the Modbus Slave address (default = 1) for the 254 in the Slave Address. If the MUCM is talking to the UPS then the UPS data will be displayed. If the MUCM is not talking to the UPS then "Read Reply Timeout" will be displayed.

---

## 7 Front Panel Operation

### ***Keypad Buttons***

The front panel includes five push buttons.

-  The RIGHT arrow advances to the next screen or field. In many cases, it has the same behavior as the  ENTER key.
-  The LEFT arrow escapes to the previous screen or field. Changes are saved when the left arrow is pressed.
-  The UP arrow moves up in a list or increments a selection.
-  The DOWN arrow moves down in a list or decrements a selection.
-  The ENTER key accepts the values on a screen and exits to a previous screen.

### ***LCD Screen***

The MUCM includes a high resolution LCD screen main screen to assist the user in configuring and troubleshooting the device. Serial port parameters and may be observed and modified. Statistical information is also provided through the front panel interface.

### ***Backlight***

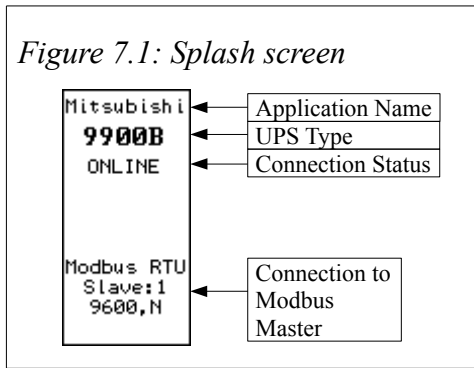
The LCD backlight will illuminate on any button press. The timeout for the backlight is set for 5 minutes.

### ***Operating Screens***

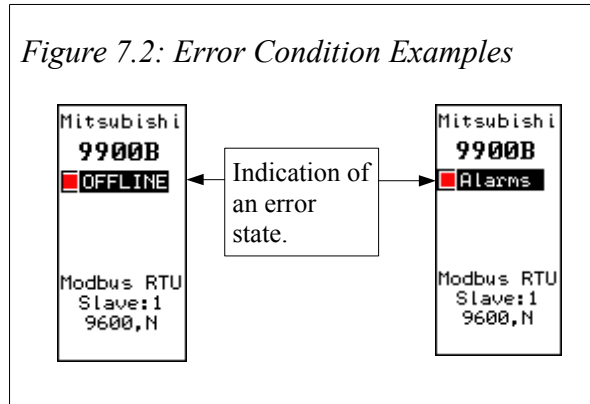
#### ***Splash Screen***

The main page shows the application name, UPS type and the connection status for both UPS and Modbus network.



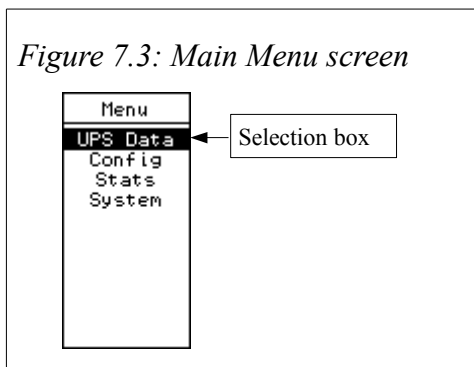


Error conditions may be displayed on the splash screen as they occur. Indications for Offline and Alarms are shown. Certain errors will light the backlight or one of the two red LEDs set behind the LCD to draw attention to the error state.



## Main Menu Screen

Pressing a key while the splash screen is displayed will move to the Main menu page. A selection box indicates the sub-menu to be chosen. Pressing the UP or DOWN arrows will move the selection box to the next choice. Pressing the RIGHT arrow or ENTER buttons will select the sub-menu. Pressing the LEFT arrow will return to the splash screen page.



## UPS Data

The UPS Data screen shows a series of screens containing data from the UPS. The screens displayed are dependent on the type of UPS configured. Some of the screens are Alarm, Input, Output, Bypass, Battery and Modbus value.

Figure 7.4: UPS Data Alarms Screen Examples

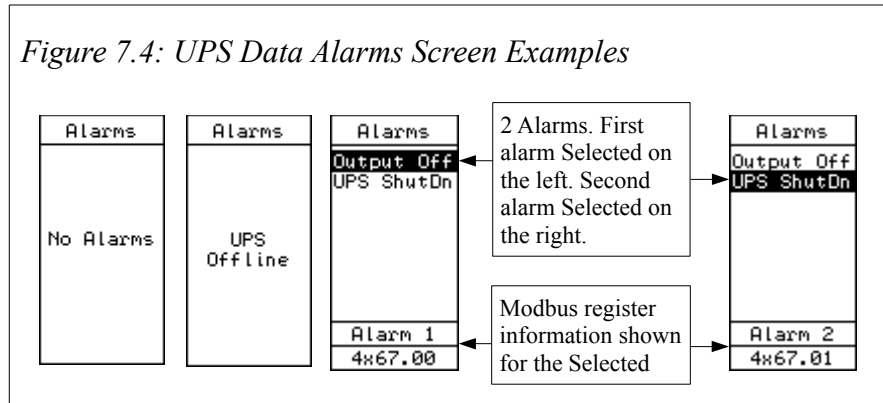


Figure 7.5: UPS Data Input Screen Examples

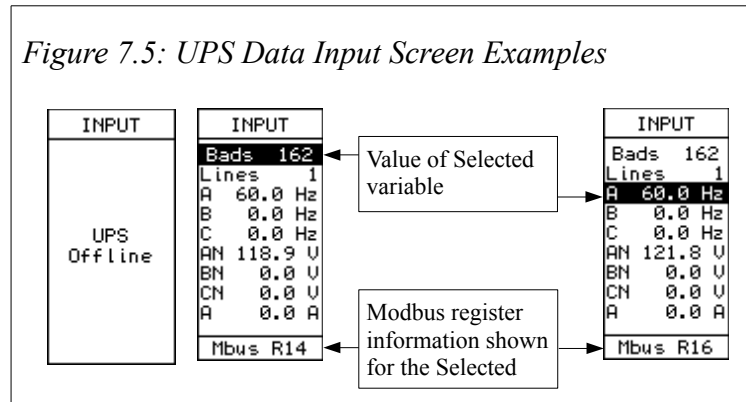


Figure 7.6: UPS Data Output Screen Examples

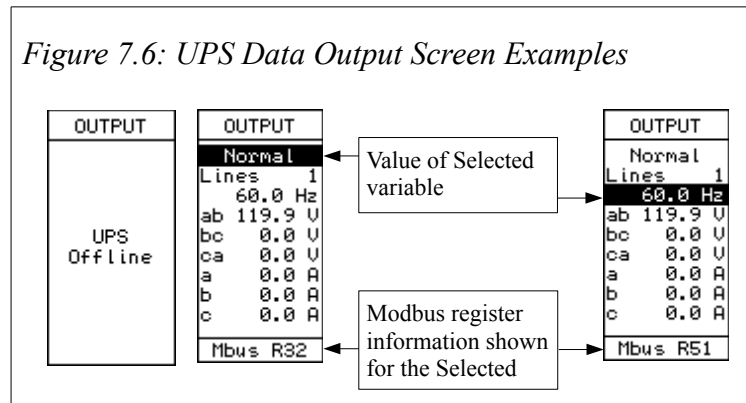


Figure 7.7: UPS Data Bypass Screen Examples

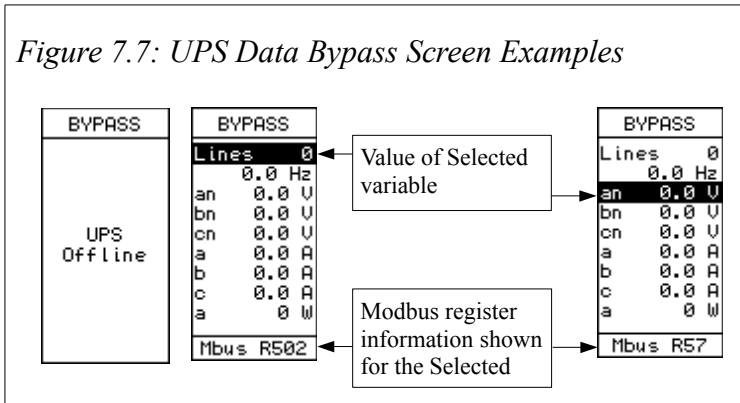


Figure 7.8: UPS Data Battery Screen Examples

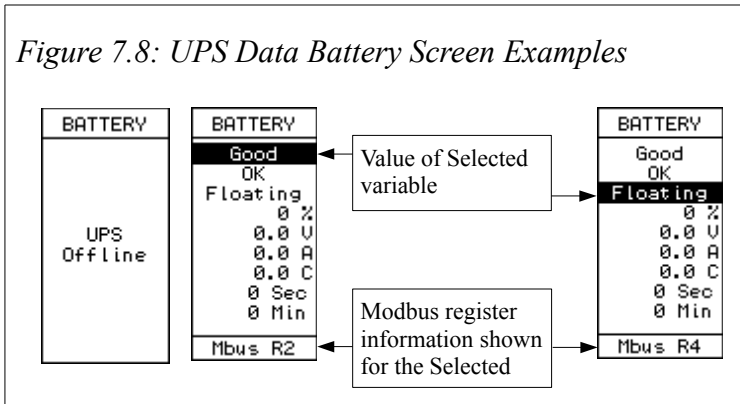
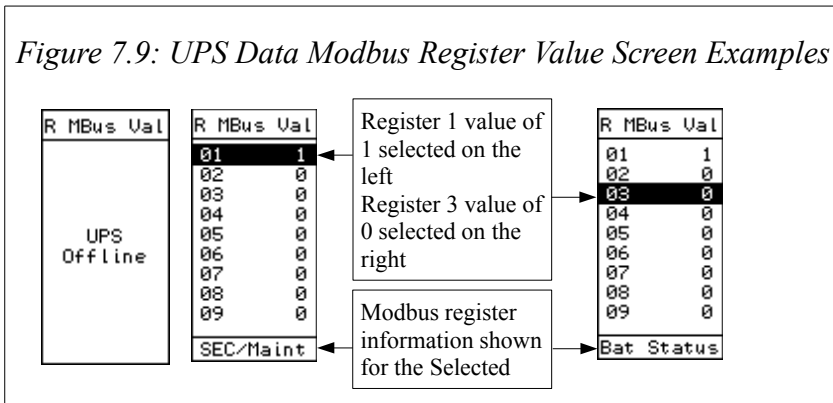


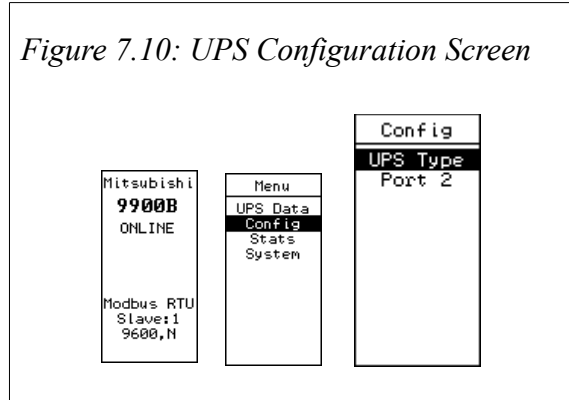
Figure 7.9: UPS Data Modbus Register Value Screen Examples



## Config Menu

The Config menu is used to configure the application for the correct UPS and to set the port 2 serial parameters

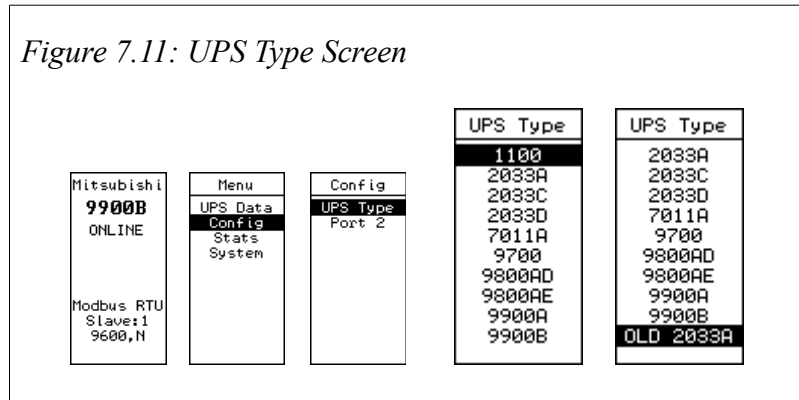
*Figure 7.10: UPS Configuration Screen*



## UPS Type

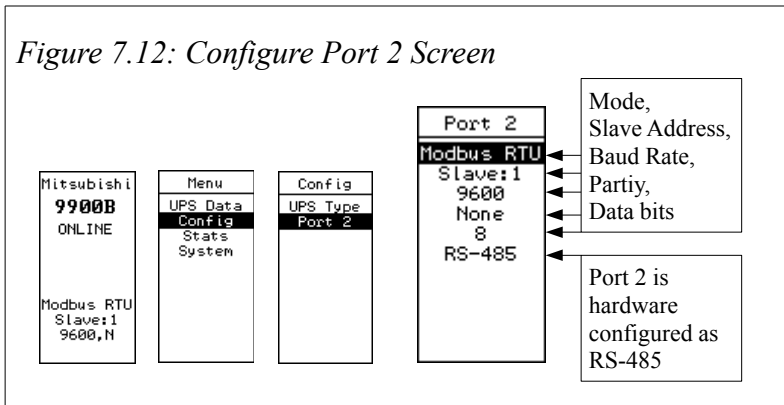
Menu used to select the UPS type. UPS types available 1100, 2033A, 2033C, 2033D, 7011A, 9700, 9800AD, 9800AE, 9900A, 9900B, and OLD 2033A.

*Figure 7.11: UPS Type Screen*



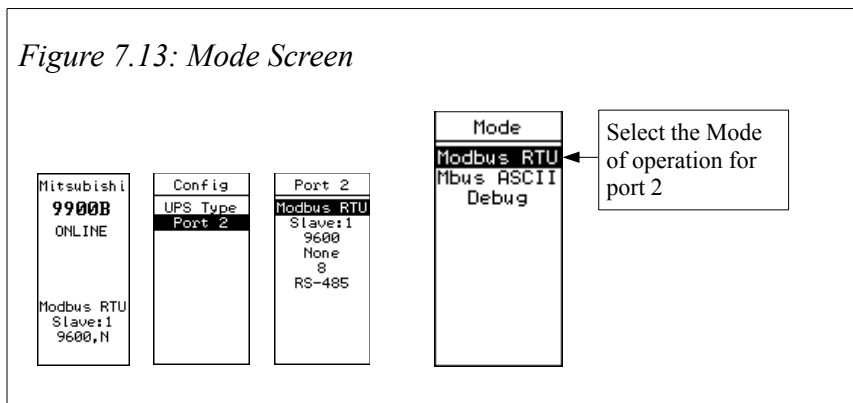
## Port 2 Menu

Port 2 menu is used to set port 2 operating parameters. Select the Mode, Slave address, Baud rate, Parity, Data bits



## Mode Menu

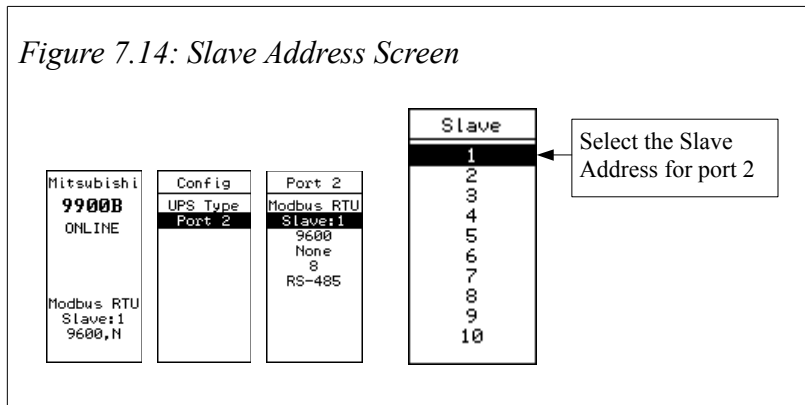
The Mode Menu is used to set the mode of operation for port 2. Modbus RTU, Modbus ASCII, and Debug are the choices. The Mode should be chosen to match the operation of the Modbus master. The Debug mode is used to trouble shoot serial communications issues. See Chapter 6 Testing and Troubleshooting



## Slave Address Menu

Select the Modbus Slave Address for port 2. Valid choices are any number between 1 and 253.

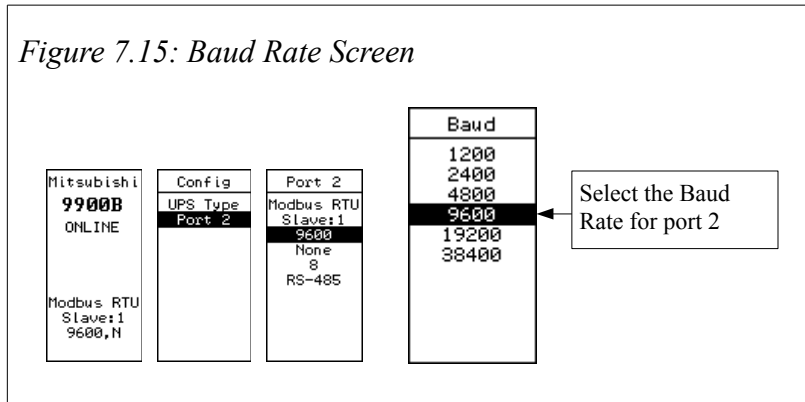
*Figure 7.14: Slave Address Screen*



## Baud Rate Menu

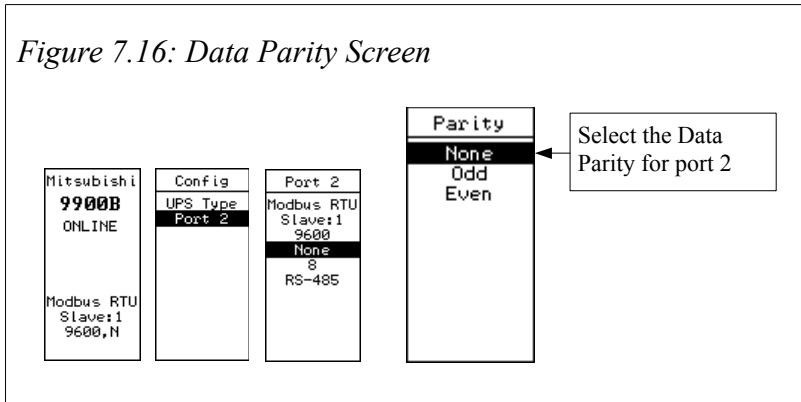
Select the Baud Rate for port 2. Valid choices include 1200, 2400, 4800, 9600, 19200, and 38400.

*Figure 7.15: Baud Rate Screen*



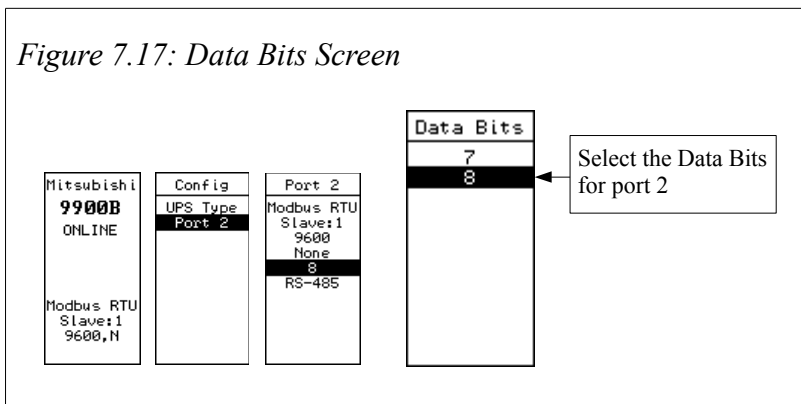
## Data Parity Menu

Select the Data Parity for port 2. Valid choices are None, Odd, and Even.



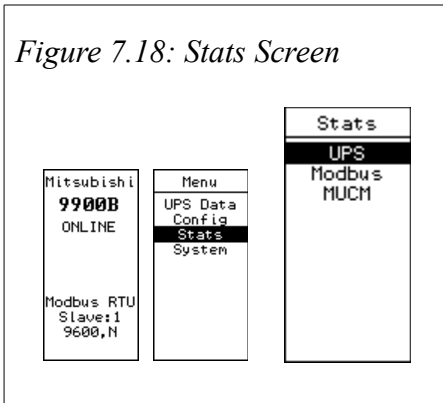
## Data Bits Menu

Select the Data Bits for port 2. Valid choices are 7, and 8. Modbus RTU must use 8 Data Bits.



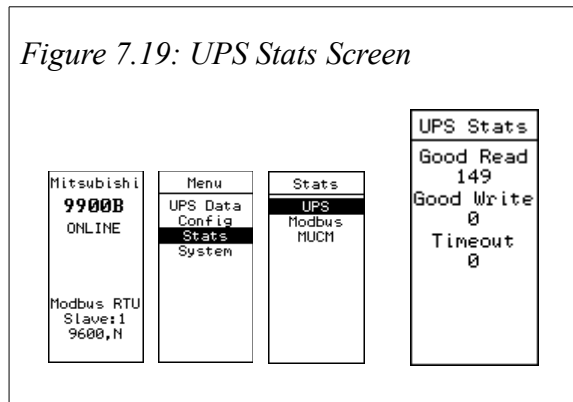
## Stats Menu

The Stats Menu shows communication statistics for the UPS and Modbus port. Pressing the Enter key will reset the counts displayed in these screens.



## UPS Statistics Screen

Shows statistics on the UPS communications.



## Modbus Statistics Screen

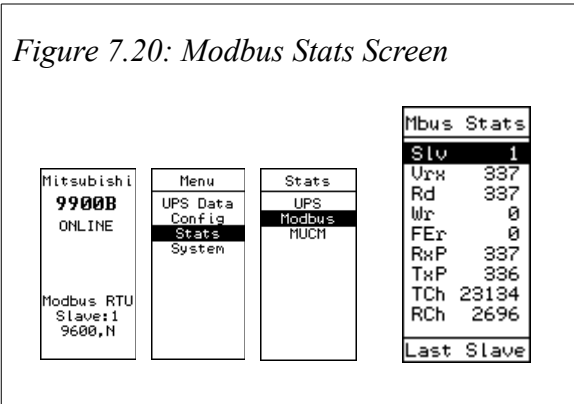
The names for the statistics displayed on this screen are abbreviated. A less abbreviated name is displayed at the bottom of the screen for the selected statistic.

The statistics displayed on this screen are:

- Slv – Last Slave polled by the master
- Vrx – Valid messages received
- Rd – Good read
- Wr – Good write

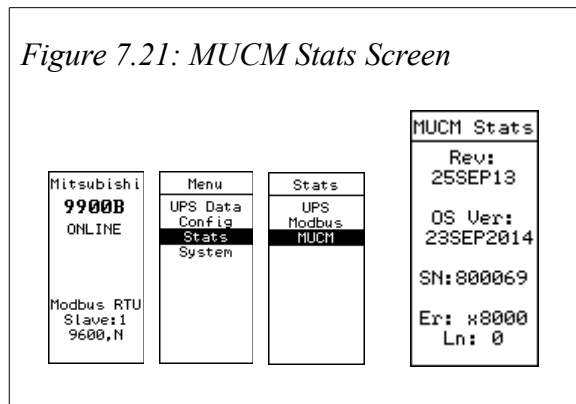


- FEr – Framing error
- RxP – Received packets
- TxP – Transmitted packets
- TCh – Transmitted characters
- RCh – Received characters



## MUCM Statistics Screen

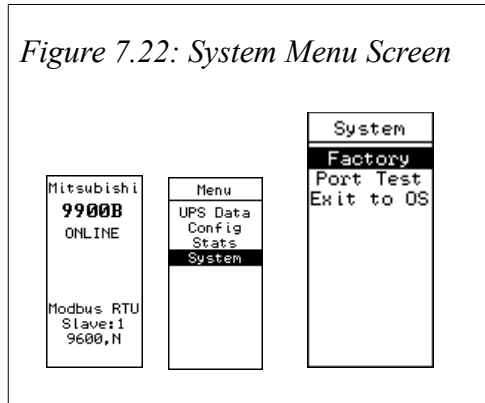
The MUCM Stats screen shows hardware revision, OS Version, Module serial number, and application error code and line number.



## System Menu

The System Menu provides access to the OS, reset settings to factory defaults, and to a loop back serial port test.

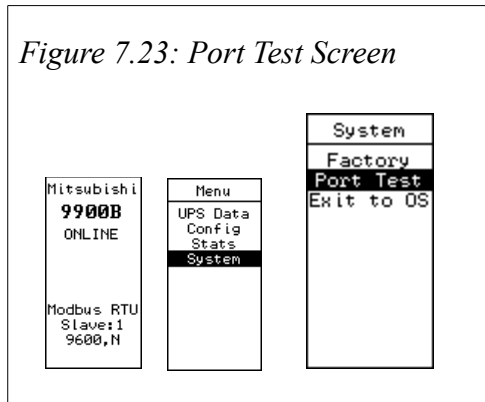
*Figure 7.22: System Menu Screen*



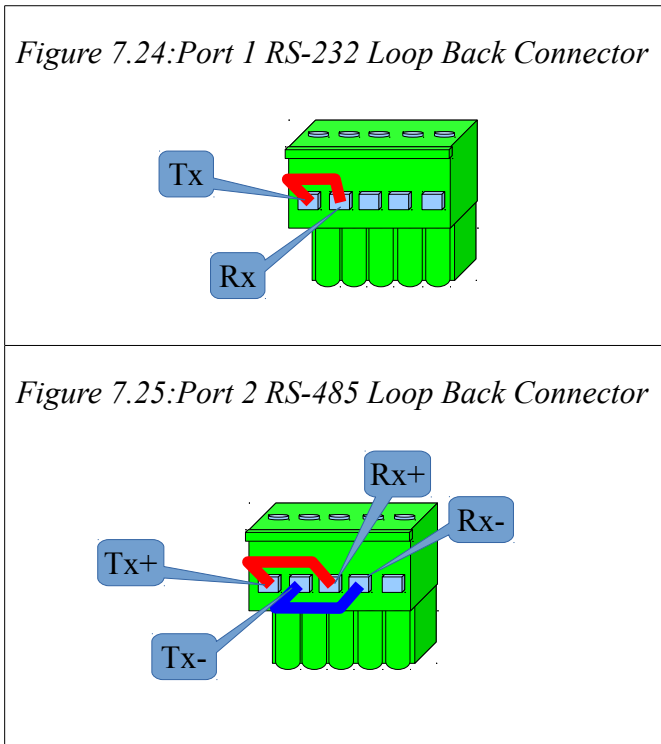
## Port Test

Port test provides a loop back test of the serial port operation. To perform the test connect the Rx to the Tx pins on each port.

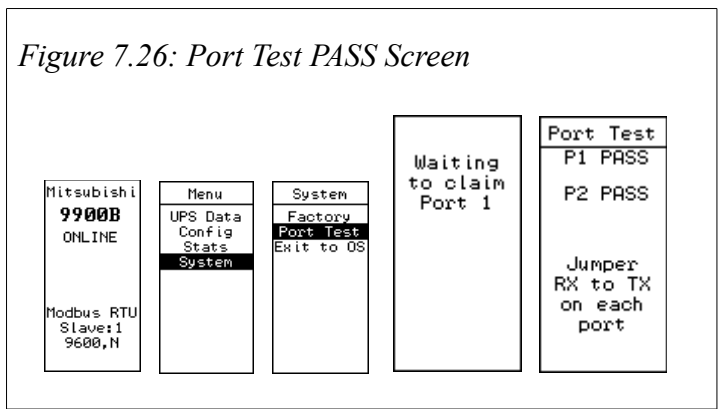
*Figure 7.23: Port Test Screen*



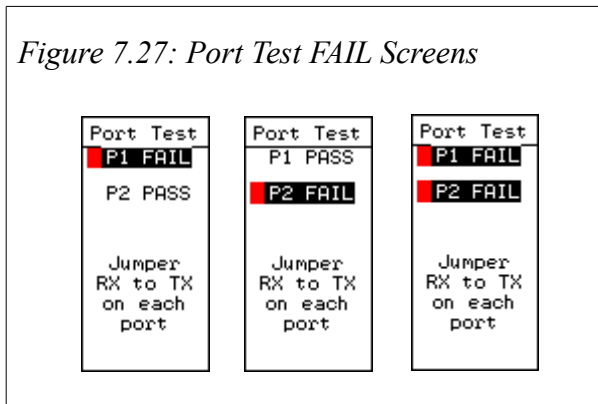
1. Make the loop back connectors as shown in Figure 7.24 and Figure 7.25



2. Place the RS-232 loop back connector on port 1 and the RS-485 loop back connector on port 2
3. Start the Port Test. The test will wait for each port to be ready then will begin sending test messages out each port. If the messages are received at each port then the screen will indicate PASS on each port as in Figure 7.26.



4. If either of the ports fail the test then the screen will indicate FAIL as in Figure 7.27



---

## 8 Software Installation

### **Software Installation**

**NOTICE:** If the MUCM was ordered from Mitsubishi or from Niobrara with the part number MCP-104 then the latest Mitsubishi application and firmware is already loaded.

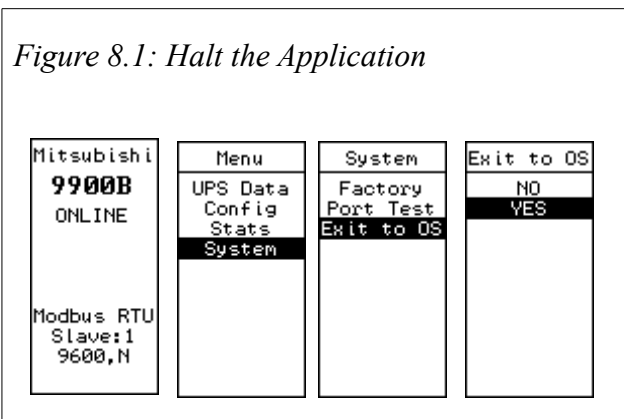
The application files for the MUCM are included in the MUCM\_MITSUBISHI\_SETUP.EXE file. The latest version of this file is located at [www.niobrara.com](http://www.niobrara.com). Follow the link for “Application Notes”, select “MUCM”, and “MITSUBISHI”.

The program MUCM\_SETUP.EXE is also required to be run before the MITSUBISHI program may be loaded into the MUCM. The MUCM\_SETUP program installs the QLOAD program and the FWLOAD program.

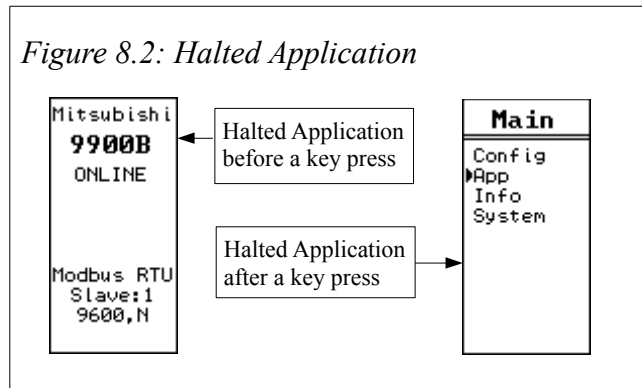
### **Updating the Application in the MUCM**

The QLOAD program is used to install the mucm3\_mitsubishi program.

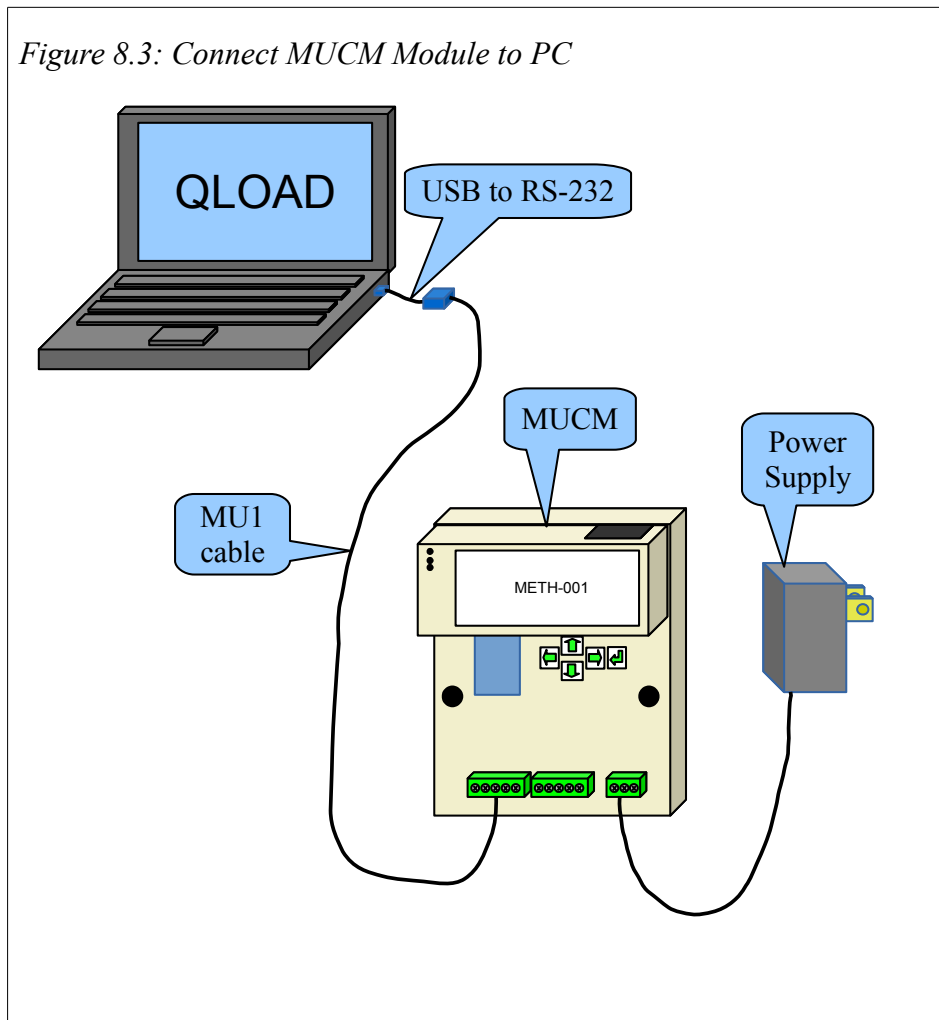
1. The module must be powered.
2. The application must be halted. To accomplish this, use the arrow keys on the module to navigate to the Main menu. Use the Enter or Right arrow button to select the System option. Select the Exit to OS option in the System menu. Use the Enter or Right arrow button to select the YES option. See Figure 8.1



When the application halts the operation of the arrow keys and the LCD screen is handled by the MUCM OS. The OS does not continuously paint the LCD screen so the last screen displayed when the application halted will remain on the screen until a key is pressed. Press the Up, Down, or Left arrow keys will bring up the OS Main Menu. See Figure 8.2



3. Connect the MU1 cable from the module port 1 to the PC.



4. Start QLOAD.EXE. The Windows Start Menu link is “Start, Programs, Niobrara, MUCM, Apps, Mitsubishi, QLOAD\_Mitsubishi” See Figure 8.4

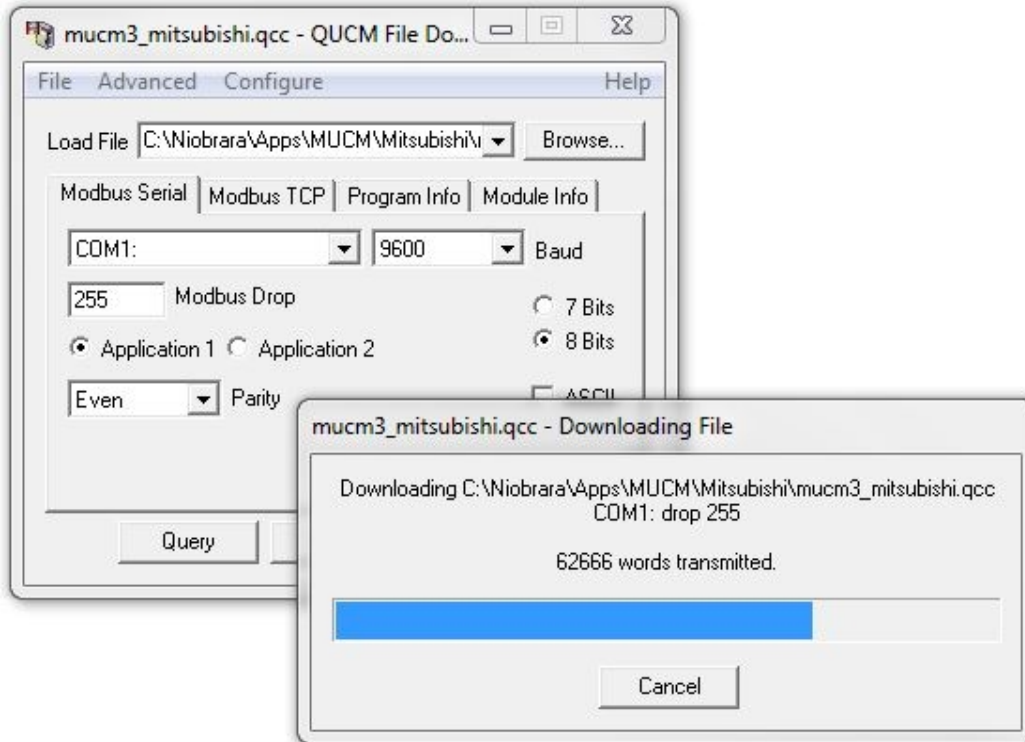
Figure 8.4: QLOAD Application



5. If necessary, Click on the Browse button and select mucm3\_mitsubishi.qcc.
6. Click on the “Modbus Serial” tab and verify the following:
  1. The proper PC serial port is selected (COM1, COM2,...).
  2. The baud rate matches the baud rate of the module (default is 9600).
  3. The Modbus Drop is 255.
  4. The Application 1 radio button is selected.
  5. The Parity matches the parity of the module (default is Even).
  6. The number of data bits match that of the module (default is 8 bits).
  7. ASCII is NOT checked.

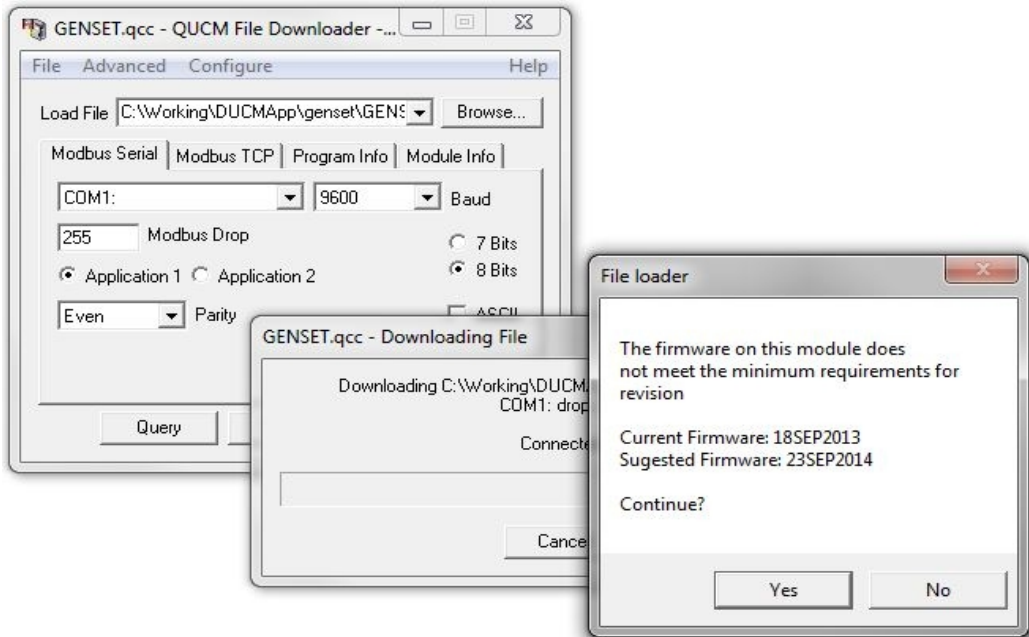
7. Press the “Start Download” button. QLOAD will open a progress bar to show the status of the download see Figure 8.5.

Figure 8.5: QLOAD Progress



If the Firmware Warning dialog appears click “No” and refer to the Updating the MUCM Firmware section of this manual see Figure 8.6.

Figure 8.6: QLOAD Firmware Warning Dialog

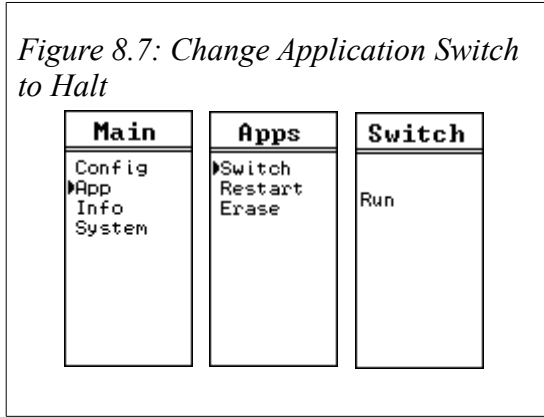




8. The application Switch must be in Run for the application to be executed:

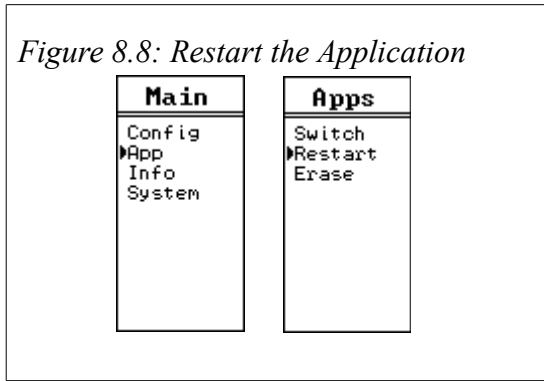
To accomplish this, use the arrow keys on the module to navigate to the App option in the Main menu. Use the Enter or Right arrow button to select the option. Select the Switch option in the Apps menu. Use the Up or Down arrow to select the Run option. Use the Enter or Left arrow to accept the choice. See Figure 8.7

*Figure 8.7: Change Application Switch to Halt*



or Restart the application. Use the arrow keys on the module to navigate to the App option in the Main menu. Select the Restart option in the Apps menu. See Figure 8.8

*Figure 8.8: Restart the Application*



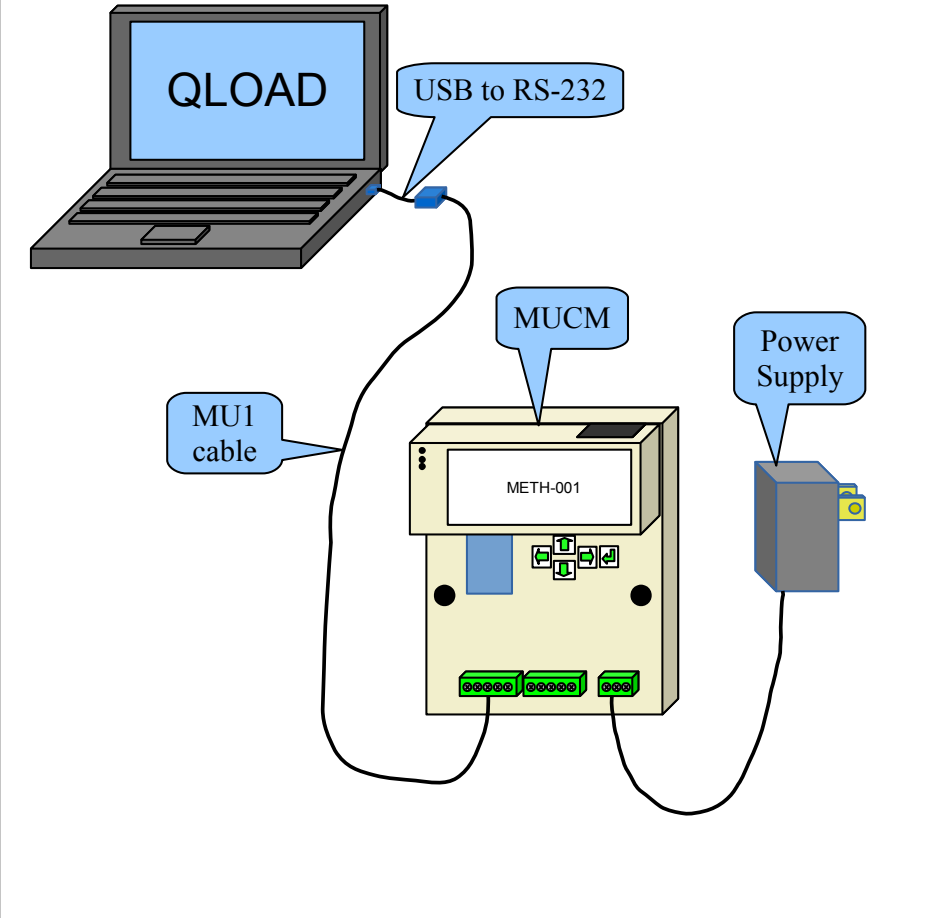
## Updating the MUCM Firmware

The QLOAD program may be used to install the module firmware through a Serial port connection using Modbus RTU.

### Start QLOAD.EXE from Windows Start Menu:

1. Make sure the MUCM is powered and connected to the PC

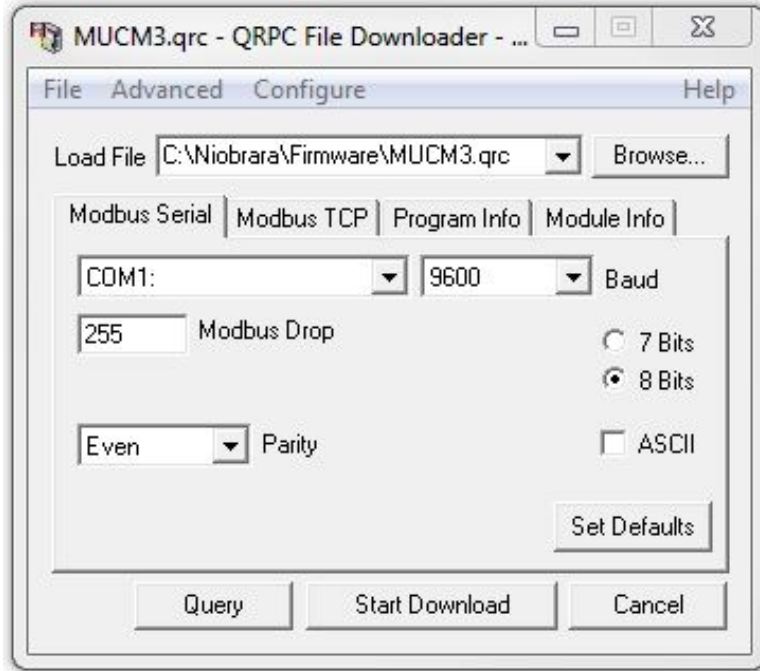
Figure 8.9: Connect MUCM Module to PC



2. Start QLOAD.EXE. The Windows Start Menu Link is “Start, All Programs, Niobrara, MUCM, QLOAD MUCM Firmware”
3. Click on the “Modbus Serial” tab and verify the following:  
See Figure 8.10
  - a) The proper PC serial port is selected (COM1).
  - b) The Baud rate matches baud rate of the module.
  - c) The Modbus Drop is 255.

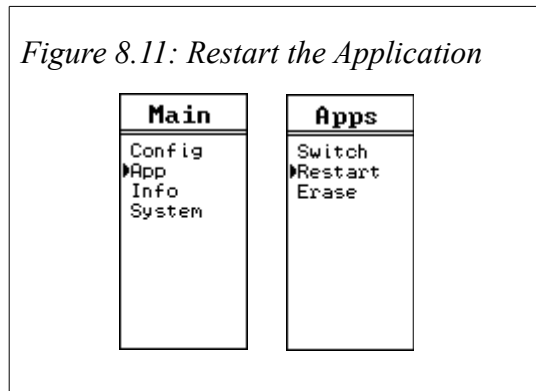
- d) Application 1 is selected.
- e) The Parity matches the parity of the module.
- f) Number of data bits match that of the module.
- g) ASCII is NOT checked.

*Figure 8.10: Using QLOAD to update firmware*



4. Press the “Start Download” button. QLOAD will open a progress bar to show the status of the download. When the download is complete the application may have to be restarted. To accomplish this, use the arrow keys on the module to navigate to the App option in the Main menu. Use the Enter or Right arrow button to select the option. Then select the Restart option in the Apps menu. See Figure 8.11

*Figure 8.11: Restart the Application*



## Appendix A Purchasing Options

The part numbering scheme for the Mitsubishi kit:

MCP-104-XXX-YYY

XXX: Three digit code for custom MLWF program preloaded

- 013 - MLWF-013 for 2033A and 9700 UPS
- 014 - MLWF-014 for 2033C UPS
- 015 - MLWF-015 for 2033D, 7011, and 9800AD UPS

Y: Single digit code for transformer

- 0 - for no transformer
- 1 - for TR121ST transformer

ZZ: Two digit code for MU Cable(s) included in the kit

- 01 - MU1 cable included 9-pin serial cable used with 2033C, 2033D, 7011, and 9800AD
- 17 - MU17 cable included 25-pin serial cable used with 2033A, 9700

Example part numbers:

MCP-104-101 - MUCM+302 preloaded with Mitsubishi application, METH-001, wall transformer for MUCM (no connector), MU1 cable

MCP-104-013 - MUCM+302 preloaded with Mitsubishi application, MLWF-013 preloaded with 2033A and 9700 App., no cables or transformer

MCP-104-014-017 - MUCM+302 preloaded with Mitsubishi application, MLWF-014 preloaded with 2033C App., MU1, MU17, no transformer

MCP-104-014-117 - MUCM+302 preloaded with Mitsubishi application, MLWF-014 preloaded with 2033C App., MU1, MU17, wall transformer