

**Mitsubishi Electric Power Products, Inc.**  
**BC7 Battery Cabinet**  
Installation, Operation, & Maintenance Manual

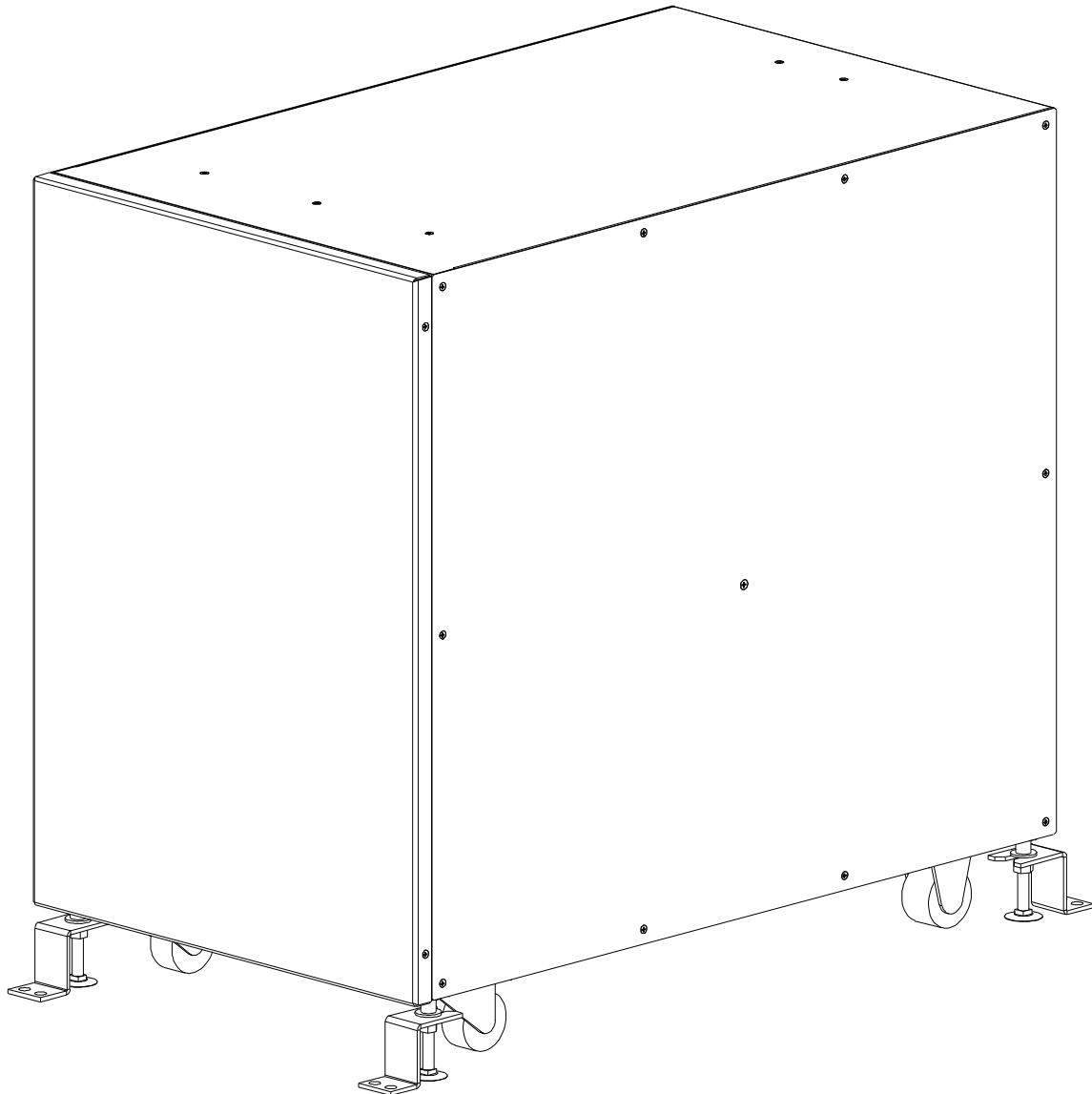



This manual contains proprietary and confidential information of C&C Power, Inc., and has been prepared for the use of Mitsubishi Electric Power Products, Inc., for use in conjunction with equipment provided by C&C Power, Inc. Unauthorized reproduction, in whole or in part, without written permission of C&C Power, Inc., is prohibited.

Copyright © 2012 C&C Power, Inc.  
All rights reserved.

**C&C Power, Inc.**

395 Mission St.  
Carol Stream, IL 60188

[www.ccpower.com](http://www.ccpower.com)

**Technical Support:**

Phone: (630) 617-9022  
Email: [support@ccpower.com](mailto:support@ccpower.com)



## TABLE OF CONTENTS

1. Important Information About This Manual .....	6
1.1 Manual Symbols .....	6
2. Introduction: .....	7
3. Safety Precautions .....	8
4. Inspection Upon Receipt of Goods.....	10
4.1 General .....	10
4.2 Visible Damage .....	10
4.3 Concealed Damage.....	10
4.4 Return of Damaged Goods .....	10
5. System Overview .....	11
6. System Specifications.....	12
6.1 Batteries.....	12
6.2 System Grounding.....	12
6.3 DC Output .....	12
6.4 General Specifications.....	12
7. Installation .....	14
7.1 Preparation.....	14
7.1.1 Equipment Inspection.....	14
7.1.2 Necessary Equipment and Tools .....	14
7.1.3 Installation Safety Precautions .....	14
7.2 Installation Steps .....	15
7.2.1 Equipment Location .....	15
7.2.2 Equipment Mounting.....	15
7.2.3 Equipment Grounding .....	15
7.2.4 DC Connections.....	16
7.2.5 System Operation .....	16
8. System Maintenance.....	17
8.1 Battery Replacement .....	17
9. Reference Materials.....	19
10. Warranty .....	21

## **1. IMPORTANT INFORMATION ABOUT THIS MANUAL**

SAVE THESE INSTRUCTIONS! This manual contains important information that is needed during the installation and maintenance of the system.

### **1.1 MANUAL SYMBOLS**

**Warning:**

Indicates information provided to protect the user against personal injury and/or safety hazards.

**Caution:**

Indicates information provided to protect the user against safety hazards and/or possible equipment damage.

**Important:**

Indicates information provided as an installation or operating instruction or tip as well as general important installation and system information.

**2. INTRODUCTION:**

The C&C Power family would like to thank you for choosing a C&C Power Inc. product for your equipment needs. We know there are a lot of choices in the industry and we appreciate the opportunity to supply each of our customers with the highest quality power products manufactured in the United States today. All of C&C Power's solutions are factory tested to some of the highest standards in the industry. Every battery cabinet system is Hi Pot tested to UL standards at our facility prior to shipment.

Sales support for future equipment needs or upgrades is provided by our regional sales staff and qualified representatives. All technical questions and service issues should be directed to our main office by dialing the number listed below. This is a 24-hour, 7-day service number. After normal working hours, please leave a detailed message with your phone number on the voice mail system and a qualified service representative will contact you as quickly as possible.

**C&C Power, Inc.**

395 Mission St.  
Carol Stream, IL 60188

[www.ccpower.com](http://www.ccpower.com)

**Technical Support:**

Phone: (630) 617-9022  
Email: [support@ccpower.com](mailto:support@ccpower.com)

### **3. SAFETY PRECAUTIONS**



Before installing or maintaining this system, it is extremely important to read this manual and be sure that all system drawings and schematics are reviewed and clearly understood. If there are any questions concerning this manual or any of the installation or maintenance procedures and/or requirements please contact a C&C Power representative before proceeding.



When installing this power system, follow all applicable federal, state and local regulations as well as industry guidelines to insure proper system installation.



Only qualified electricians or DC power technicians should attempt to install or service this equipment.



System installation and maintenance should always be performed with heavily insulated tools. It is also recommended to wear rubber gloves, boots, and use insulating mats to stand on when working on this equipment.



Always wear eye protection when installing or maintaining batteries and/or power equipment.



Battery cabinet systems are extremely heavy. Use a minimum of two people when unloading and setting equipment in place.



Do not smoke or present open flames near any battery system.



For the safety of others, never leave an open cabinet or panel unattended.



To reduce the risk of fire, replace fuses with the same type and rating of fuses supplied with the system.



DC Power and Batteries can be very dangerous and have extremely high short circuit current. Electrical shock, severe burns, fire or death can result from a system short.





To avoid personal injury including electrical shock, severe burns and possible death, all jewelry including bracelets, rings and watches must be removed prior to installing or servicing this system.



Do not open or mutilate batteries. Opened or severely damaged batteries can release toxic electrolyte which is harmful to the skin and eyes.



Never lay loose cables, metal parts or tools on top of batteries.



Under certain conditions, batteries can vent potentially explosive gas (hydrogen). Never enclose batteries or battery cabinets in a sealed room.

## **4. INSPECTION UPON RECEIPT OF GOODS**

### **4.1 GENERAL**

Special precautions and care have been taken to ensure the system arrives safe and undamaged. However, upon receipt, you should inspect the entire shipment, including the crate and any boxes for evidence of damage that may have occurred during transit.

### **4.2 VISIBLE DAMAGE**

It is the responsibility of the person receiving the shipment to inventory and fully inspect all materials against the bill of lading or weigh bill IMMEDIATELY while the carrier representative is still present. Insure that all items are accounted for, including number of skids and quantity of boxes. Also note any visible external damage that may have occurred during transit. Make all applicable notations on the delivery receipt before signing and file a damage report with the carrier.

### **4.3 CONCEALED DAMAGE**

Within 3 to 30 days of receipt (depending on courier), unpack the system and check for any concealed damage. Check the materials received against the detailed packing list to verify the quantity and the condition as complete and satisfactory.

Note any damage to the internal packaging, then request an inspection by the carrier and file a concealed damage claim. If there is a material shortage, contact a C&C Power representative at the main office to file a claim.

**Please contact your shipping company for all shipping damage.  
C&C Power is not responsible for any shipping damage.**

### **4.4 RETURN OF DAMAGED GOODS**

Should equipment be damaged and require return to C&C Power for repair, a representative will provide instructions along with an RMA number to expedite the return.

**A RMA number must be obtained before returning equipment to C&C Power, Inc.**

## **5. SYSTEM OVERVIEW**

During normal operating conditions the UPS supplies power to the load as well as the necessary power required to keep the batteries at the proper float voltage. When AC power fails, the batteries will discharge in order to provide the necessary backup power to the load. It is the responsibility of the customer to make sure the batteries are not discharged below manufactures recommendations. After any battery discharge has occurred, the batteries should be recharged as soon as possible. Batteries will be damaged if not properly recharged right away. See the UPS manual for more information on charging the batteries.

**6. SYSTEM SPECIFICATIONS**

**6.1 BATTERIES**

Please refer to system drawings for model specific information.

**Type:** Valve Regulated Lead Acid (VRLA), sealed, non-spillable

**Voltage:** 12 VDC Nominal

 Only cabinets with **Flame Retardant Batteries** are suitable for computer room use.

**6.2 SYSTEM GROUNDING**

 All system ground wires should be derived from the main building ground source.

**Cabinet Safety Ground:** Each cabinet is supplied with a mechanical ground lug that accepts bare wire from #6 AWG to 300 MCM cable.

**Torque:** 325 lb-in

**Wire Size and Type:** Ground wire should be sized per NEC and/or all applicable national and local codes.

Battery Cabinet Breaker or Fuse Size	Minimum Copper Ground Wire Size
Up to 200 amps	6 AWG
201-300 amps	4 AWG
301-400 amps	3 AWG
401-500 amps	2 AWG
501-600 amps	1 AWG

**6.3 DC OUTPUT**

Please refer to system drawings for model specific information.

**Voltage:** 12-480 VDC Nominal

**Circuit Breaker:** UL Listed 600 VDC rated. See system drawings for details.

**Fuse Type:**

A50QS, A50P or equal (for 384VDC Nom. bus or less)

A70QS, A70P or equal (for 480VDC Nom. bus or less)

HSJ

**Wire Size and Type:** Per NEC and/or all applicable national and local codes.

 Wire should be sized for a maximum voltage drop of 0.5 volt.

**6.4 GENERAL SPECIFICATIONS**

**Cabinet Size:** 17.9”W x 29.9”D x 27.7”H

**Empty Cabinet Weight (approximately):** 74 lbs.

**Operating Temperature:** 20°C to 25°C (68°F to 77°F) recommended for optimum battery performance.

**Ventilation:** Through ventilation slots front and rear. A minimum of four inches is required in front and behind the cabinet. This refers to obstruction of ventilation only. Clearance around the equipment should be as suggested by NEC and/or all applicable national and local codes.



Under certain conditions, batteries can vent potentially explosive gas (hydrogen). Never enclose batteries or battery cabinets in a sealed room.



Batteries should be stored no longer than three months at 25°C (77°F) or lower before recharging. Exceeding the recommended ambient storage temperature may cause damage to the batteries.

## **7. INSTALLATION**

### **7.1 PREPARATION**

#### **7.1.1 EQUIPMENT INSPECTION**

Remove the equipment from the packaging material and inspect for any shipping damage that may have been overlooked upon receipt of goods. Verify that the system includes all necessary hardware for installation.

#### **7.1.2 NECESSARY EQUIPMENT AND TOOLS**

- Heavily insulated assortment of hand tools
- Digital voltmeter

#### **7.1.3 INSTALLATION SAFETY PRECAUTIONS**



Before proceeding with system installation, be sure to review and understand all of the SAFETY PRECAUTIONS in this manual!



#### **DC VOLTAGE WARNING!**

Hazardous DC voltages are present in the system. This hazard will always be present in a battery system including when it is offline. Accidental short circuit of the positive and negative terminal will cause tremendous currents to flow resulting in electrical shock, severe burns, fire and possible death! Use extreme caution when installing and maintaining the system!

## **7.2 INSTALLATION STEPS**



Before installing or maintaining this system, it is extremely important to read this manual and be sure that all system drawings and schematics are reviewed and clearly understood. If there are any questions concerning this manual or any of the installation or maintenance procedures and/or requirements please contact a C&C Power representative before proceeding.

### **7.2.1 EQUIPMENT LOCATION**

Prior to installation, verify floor loading requirements and all applicable codes pertaining to the related equipment. Environmental conditions should also be reviewed. Battery systems require an area with proper ventilation and cooling. An ambient temperature between 20°C to 25°C (68°F to 77°F) is recommended for optimum battery life and performance. The cabinet has vent holes located at the front and rear of the system. Never install the cabinet into a sealed enclosure. Clearance around the equipment should be as suggested by NEC and/or all applicable national and local codes.



Under certain conditions, batteries can vent potentially explosive gas (hydrogen). Never enclose batteries or battery cabinets in a sealed room.

### **7.2.2 EQUIPMENT MOUNTING**



Battery cabinet systems are extremely heavy. Use a minimum of two people when unloading and setting equipment in place.

1. The BC7 is equipped with four casters, two swivel type casters in the front and two rigid type casters in the rear. Roll the cabinet off of the skid with the provided ramp and move the cabinet into the desired location.
2. Lower the four leveling feet located at each corner to stabilize the cabinet and prevent it from moving.
3. On the floor in the desired location, mark the location of the 4 mount holes located on the mounting brackets provided.
4. Move the cabinet out of the way and drill holes for the recommended hardware.
5. Move the cabinet back into place, align holes, and tighten hardware.
6. Should any drilling be performed on this equipment, make sure all exposed batteries and connections are completely covered using insulated type mats.

### **7.2.3 EQUIPMENT GROUNDING**



All system ground wires should be derived from the main building ground source.



For multi cabinet systems, each cabinet needs to have a designated cabinet ground wire derived from the main building ground source.

Terminate a cabinet ground wire from the main building ground source to the supplied #6-300MCM mechanical lug located on the breaker pan. See section 6.2 for sizing recommendations. Wire should be sized per NEC and/or all applicable national and local codes.

#### **7.2.4 DC CONNECTIONS**



Review the attached system drawings and schematics for model specific information on DC output connections.



Wire should be sized for a maximum voltage drop of 0.5 volt.



Battery cabinets that are not supplied with an incorporated DC output disconnect device must have an appropriate disconnect device provided external to the cabinet.



Verify that the output breaker is in the off/open position before making any DC connections to additional cabinets or to the UPS. Also verify that the UPS charger is not running.

1. Open the front door on the cabinet and check for any noticeable problems or damage that may have occurred during shipment.
2. Review the attached installation drawing and schematic. A cable has been left off in the middle of the battery string for safety and will be installed later.
3. Check and re-torque internal battery connections, as shipping may have caused these connections to come loose. Proper torque values are noted on the drawing and also on the battery case.
4. Connect main cables from the UPS or charger source to the battery cabinet output. The battery cabinet output connection point will vary depending on the cabinet configuration. The main output connection point may be directly to the circuit breaker, to the fuse block, or to a terminal block or bus bars. Review the supplied cabinet drawing for information on the battery cabinet output. All cables should be sized per NEC and any other local codes pertaining to this equipment. Refer to the UPS or charger manual for wiring external batteries. Note: Make sure charging source is disconnected before making these connections.
5. Connect the cable that was left off during shipment and install as shown on the drawing. Torque connections properly.

#### **7.2.5 SYSTEM OPERATION**

Please refer to the UPS system manual for system start up and operation information.



## **8. SYSTEM MAINTENANCE**



Before proceeding with system maintenance, be sure to review and understand all of the SAFETY PRECAUTIONS in this manual!



Verify that the output breaker is in the off/open position before servicing the system.

### **8.1 BATTERY REPLACEMENT**



When batteries are replaced they must be properly installed paying special attention to terminal polarity orientation! If wired incorrectly it will cause a short in the system and can result in electrical shock, severe burns, fire and possible death! Be sure to review the system schematics before terminating any battery cables.



Caution: Risk of explosion if batteries are replaced by an incorrect type.



Do not dispose of batteries in a fire. The batteries may explode. Contact your local hazardous waste or recycling center for battery disposal requirements.

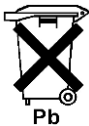

Do not discard batteries in the trash. This product contains sealed lead acid batteries. Contact your local hazardous waste or recycling center for battery disposal requirements.

1. Prepare the new battery for installation. Verify that the battery is the same type and amp-hour rating as the batteries that are in the system.
2. Using a digital voltmeter, measure the battery voltage to verify that it is 12.4 VDC or above.
3. Use a brass wire brush or abrasive pad to polish the battery terminals.
4. Apply no-ox type terminal grease to the battery terminals to avoid corrosion.
5. Disconnect the UPS from the battery string by turning off/opening the circuit breaker in the battery cabinet.
6. Remove the center jumper on the battery string to reduce the voltage. If replacing all batteries, continue reducing the voltage by removing the inter-shelf jumpers.
7. Disconnect the cables from the battery to be replaced.
8. Remove the bad battery. Depending on battery location, it may be necessary to remove additional batteries to safely gain access to the bad battery.
9. Put the new battery into place. Make sure new battery is installed properly regarding polarity orientation. Use the supplied wiring drawing found inside the battery cabinet door to verify the cabinet wiring.
10. Reconnect the cables to battery and make sure the connections are properly torqued.

11. Reconnect any removed string jumpers and make sure the connections are properly torqued.
12. Check the battery string voltage at input side of the circuit breaker.
13. Reconnect the UPS to the battery string by turning on/closing the circuit breaker in the battery cabinet.

**9. REFERENCE MATERIALS**

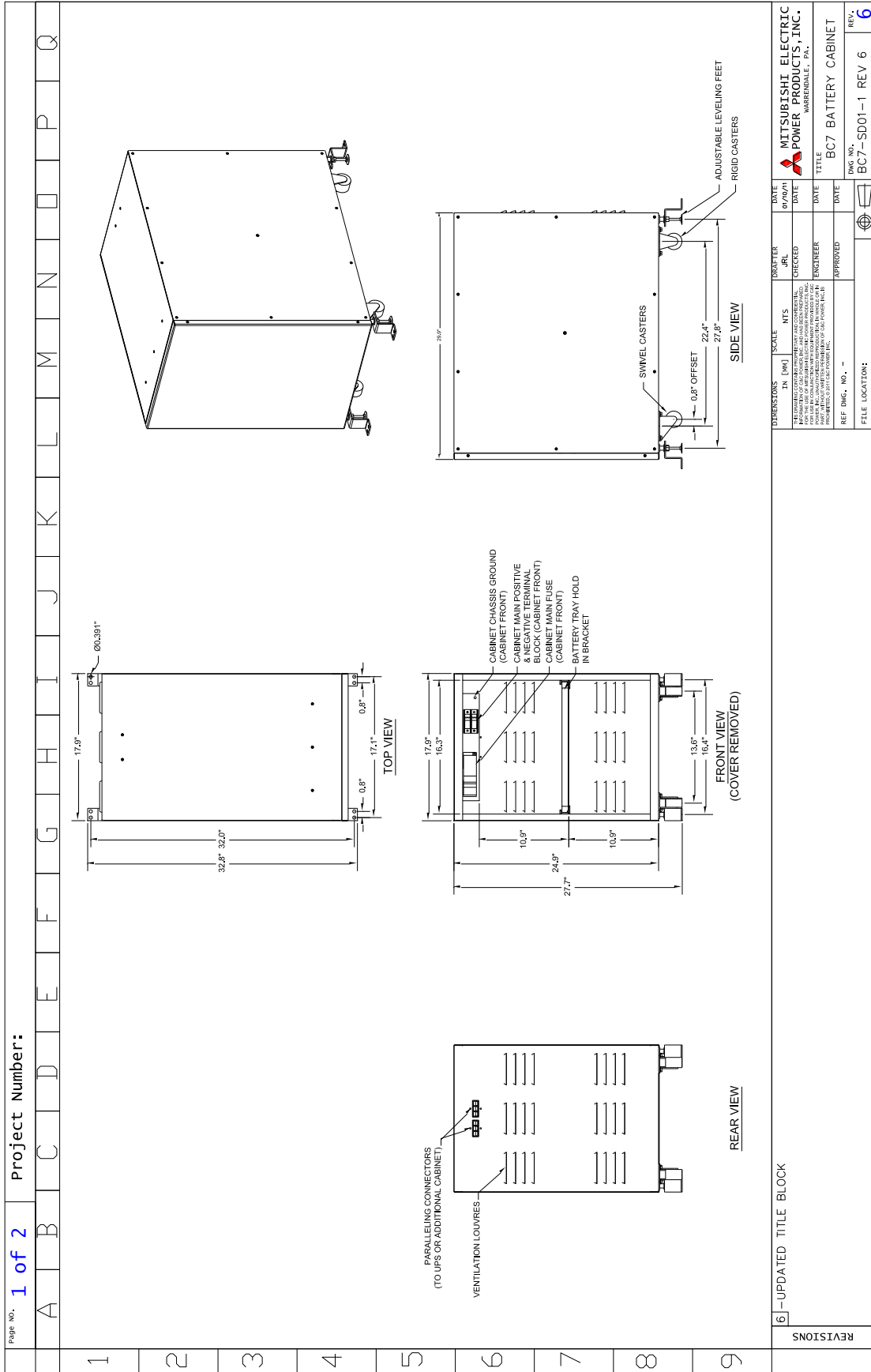

DIMENSIONS	SCALE	DATE	DATE	DATE	DATE	DATE	DATE
IN (MM)	NTS	DRAFTER	JRL	CHECKED	ENGINEER	APPROVED	FILE LOCATION:
REFERENCE TO THE DIMENSIONS OF THE CABINET SHALL BE TO THE DIMENSIONS OF THE CABINET AS SHOWN IN THE DRAWING. THE DIMENSIONS OF THE CABINET SHALL BE TO THE DIMENSIONS OF THE CABINET AS SHOWN IN THE DRAWING. THE DIMENSIONS OF THE CABINET SHALL BE TO THE DIMENSIONS OF THE CABINET AS SHOWN IN THE DRAWING.							
MITSUBISHI ELECTRIC POWER PRODUCTS, INC. WARDENVILLE, PA.							
TITLE: BC7 BATTERY CABINET							
DWG. NO.: BC7-SD01-1 REV 6							
REV. 6							

**TYPICAL FUSE SIZING**

7071A SERIES UPS SIZE	6 KVA	8 KVA	10 KVA	12 KVA
FUSE TYPE	A4J40	A4J60	A4J60	A4J60
TB OUTPUT CONNECTIONS	(1) #2 PER POLE	(1) #2 PER POLE	(1) #2 PER POLE	(1) #2 PER POLE
INTERCELL CABLE	(1) #8	(1) #8	(1) #8	(1) #8

**BATTERY CABINET INFO**

PART NUMBER	QTY	SYSTEM WEIGHT
BC7-18/P007-KVAFF	1	212 LBS
BC7-18/P007-KVAFF	1	320 LBS
BC7-18/P080-KVAFF	1	356 LBS
BC7-18/P100-KVAFF	1	500 LBS
BC7-18/P2P080-KVAFF	1	608 LBS
BC7-18/P2P080-KVAFF	2	1,276 LBS
BC7-18/P2P080-KVAFF	3	2,004 LBS
BC7-18/P2P080-KVAFF	4	2,792 LBS

- BATTERY CABINET NOTES:**
- NEMA 1 ENCLOSED BATTERY CABINET.
  - FACTORY ASSEMBLED CABINETS ARE UL LISTED 1778 & CSA LISTED 22.2 NO. 107.1-M95.
  - HEAVY GAUGE WELDED STEEL CONSTRUCTION.
  - PAINT IS MITSUBISHI GRAY (MUNSELL 5.4Y7.2/0.5) POWDER COAT, OVEN BAKED FOR CHIP AND CORROSION RESISTANT FINISH. BATTERIES CAN BE ACCESSED FROM THE FRONT. SIDE COVERS ARE ALSO REMOVABLE TO FACILITATE BATTERY MAINTENANCE.
  - CABINET IS SUPPLIED ON SKID WITH HEAVY DUTY RAMP FOR EASY UNLOADING. CABINET IS TO BE MOVED USING CABINET CASTERS.

- ELECTRICAL NOTES:**
- ALL INTERNAL WIRING IS UL LISTED, MTW, STYLE, 105C, EXTRA FLEXIBLE CABLE.
  - FUSE IS UL LISTED, TYPE A4J, (40A FUSE SUPPLIED FOR 6KVA SYSTEMS & 60A FUSE FOR 8/10/12KVA SYSTEMS), SINGLE STRING 7AH SYSTEMS WILL RECEIVE 40A FUSES REGARDLESS OF KVA SIZE.
  - CABINET IS SHIPPED WITH FUSE/S REMOVED.
  - TERMINAL BLOCK IS UL RECOGNIZED, 600V RATED.
  - MAIN CABLE FROM BATTERY CABINET TO UPS SYSTEM IS INCLUDED. CABLE LENGTH IS 96". ONE END HAS A CONNECTION BOX TO MATE WITH BATTERY CABINET AND THE OTHER END HAS (3) SINGLE HOLE LUGS 1/4"Ø FOR FIELD CONNECTION TO UPS.
  - ALL CONTROL WIRING IS POWERED FROM AN OUTSIDE SOURCE.
  - GROUND CONNECTION IS PART OF THE UPS/CABINET CABLE.
  - ALL FUSE HOLDER, AND TERMINAL BLOCK CONNECTIONS ARE MECHANICAL LUG TYPE. THESE CONNECTIONS ACCEPT BARE WIRE.
  - FOR BATTERY TORQUE SPEC REFER TO BATTERY LAYOUT DRAWING INSIDE BATTERY CABINET, OR SEE LABEL ON BATTERY CASE.
  - FOR TERMINAL BLOCK TORQUE SPEC REFER TO LABEL ON TERMINAL BLOCK.
  - USE INSULATED TOOLS.
  - DO NOT ALLOW CABLES OR TOOLS TO REST ON BATTERIES.

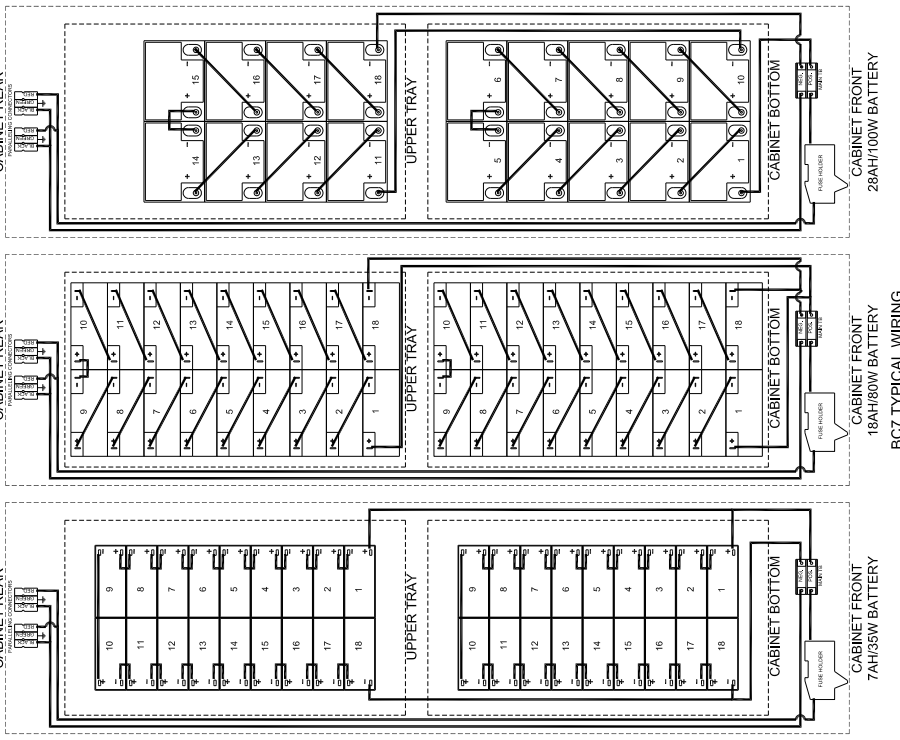

<p>6] - UPDATED NOTES, AND TITLE BLOCK.</p>		<p>DATE: 07/07/11</p> <p>DATE: 07/07/11</p> <p>DATE: 07/07/11</p> <p>DATE: 07/07/11</p>
<p>DIMENSIONS IN [mm]</p> <p>SCALE</p> <p>NTS</p> <p>CHECKED</p> <p>ENGINEER</p> <p>APPROVED</p>	<p>DATE</p> <p>DATE</p> <p>DATE</p> <p>DATE</p>	<p>DATE</p> <p>DATE</p> <p>DATE</p> <p>DATE</p>
<p>REF. IMG. NO. -</p> <p>FILE LOCATION:</p>		<p>DATE</p> <p>DATE</p> <p>DATE</p> <p>DATE</p>
<p>BC7-SD01-2 REV 6</p>		<p>REV. 6</p>

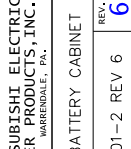

---

## **10. WARRANTY**

### **LIMITED WARRANTY AND EXCLUSIONS**

C&C Power, Inc. strives to produce quality products at reasonable prices. If you are not satisfied with our product because of a defect, we will repair or replace the defective part or parts free of charge for a period of one year from the date of purchase. In the event you claim that the product contains a defect, simply notify C&C Power, Inc. of the defect, and we will arrange for repair or replacement. The sole and exclusive remedy against C&C Power, Inc. relating in any way to a product defect shall be the repair or replacement of defective parts as provided for under this LIMITED WARRANTY. No other remedy, including, but not limited to, incidental or consequential damages for lost profits, lost sales, injury to person or property, or any other incidental or consequential loss, is available. This LIMITED WARRANTY shall not be deemed to have failed of its essential purpose so long as C&C Power, Inc. is willing and able to repair or replace defective parts in the manner prescribed in this LIMITED WARRANTY.

**Certain integrated products, which are not manufactured by C&C Power; will be warranted by the applicable manufacturer. These warranties shall be between the manufacturer and the user. Terms and conditions may vary. These integrated products include, but may not be limited to, the following products: Batteries, Inverters and UPS Systems.**

Any action for breach relating to the sale of a C&C Power, Inc. product must be commenced within one year after the cause of action has accrued.

THIS LIMITED WARRANTY IS IN LIEU OF ANY OTHER WARRANTY, EXPRESS OR IMPLIED, AND ALL SUCH WARRANTIES ARE EXCLUDED, INCLUDING, BUT NOT LIMITED TO, ANY IMPLIED WARRANTY OF MERCHANTABILITY OR FITNESS FOR A PARTICULAR PURPOSE.

